

**OKI®**



MICROLINE 320/321 Turbo /n

**9 Pin Printer**

# User's Guide



## Document Title and Part Number

Microline 320/321 Turbo/n User's Guide

Rev. 1

## Disclaimer

Every effort has been made to ensure that the information in this document is complete, accurate, and up-to-date. Oki Data assumes no responsibility for the results of errors beyond its control. Oki Data also cannot guarantee that changes in software and equipment made by other manufacturers and referred to in this guide will not affect the applicability of the information in it. Mention of software products manufactured by other companies does not necessarily constitute endorsement by Oki Data.

## Copyright Information

Copyright 2007 by Oki Data. All rights reserved.

February, 2007

Written and produced by the Oki Data Training and Publications Department.

## Contact Information

Please address any comments on this publication to:

### Mailing Address

Oki Data Americas, Inc.  
Training & Publications Dept.  
2000 Bishops Gate Blvd.  
Mt. Laurel, NJ 08054-4620

### e-Mail Address

pubs@okidata.com

### Web Site

Please visit Oki Data's multilingual web site at:

<http://www.okiprintingsolutions.com>

## Trademark Information

OKI and MICROLINE are registered trademarks of Oki Electric Industry Co., Ltd.

Epson is a registered trademark of Epson America, Inc.

IBM is a registered trademark of International Business Machines Corp.

Microsoft and Windows are either registered trademarks or trademarks of Microsoft Corporation in the United States and other countries.



As an ENERGY STAR Partner, Oki Data has determined that this product meets the ENERGY STAR guidelines for energy efficiency.

**Note:** Not comply (when employing Network Interface Card).

# Contents

<b>Helpful Hints .....</b>	<b>8</b>	<b>Introduction .....</b>	<b>13</b>
Saving Money .....	9	Printer Features .....	14
Saving Money: Forms Tear-Off .....	9	<b>Parts Identification .....</b>	<b>15</b>
Saving Money: Draft Mode .....	9	Printer Serial Number .....	15
Saving Time .....	10	Parts Identification: Rear Feed (Continuous Forms) .....	16
Saving Time: Internet Support .....	10	Parts Identification: Top Feed (Single-Sheet) .....	17
Saving Time: Draft Mode .....	10	Front Panel Lights .....	18
Saving Time: Paper Park .....	10	Front Panel Keys .....	19
Saving Time: Moving Through the Menu .....	10		
Operation Tips .....	11		
Operation Tip: Top of Form .....	11		
Operation Tip: Turning the Platen Knob .....	12		
Operation Tip: Using the Parallel Port .....	12		
Operation Tip: Control Access to the Printer .....	12		

<b>Installation .....</b>	<b>20</b>
Installation Hints .....	20
Installation Overview .....	21
Installation Location .....	21
Customizing the Installation .....	22
Unpacking the Machine .....	24
Shipping Restraints .....	25
Ribbon Cartridge .....	26
Ribbon Cartridge Handling .....	27
Ribbon Cartridge Emergency First Aid .....	27
Power Connections .....	28
Paper Loading .....	29
Testing the Printer .....	33
Font Sample Test .....	34
Rolling ASCII Test .....	35
Local Printer Installation .....	36
Installing Printer Software .....	36
Windows 95, 98, Me, NT4.0 .....	36
Windows 2000 .....	37
Network Printer Installation .....	38
Connecting the Network Cable .....	38
Network Installation .....	39
Connecting to the Parallel Port .....	40

Product Registration .....	41
my.okidata.com .....	41
Registering Your Printer .....	41

<b>Using Your Printer .....</b>	<b>42</b>		
Top of Form (TOF) .....	42	Printer Reset .....	64
Top of Form (TOF) and Forms Tear-Off .....	43	Character Pitch .....	65
Forms Tear-Off Status (ON or OFF) .....	43	Emulations .....	66
Setting Top of Form, Forms Tear-Off ON (Step A) .....	44	Printer Drivers .....	67
Setting Top of Form, Forms Tear-Off OFF (Step B) .....	46	Selecting Printer Drivers .....	67
Temporary Top of Form Change .....	48	Obtaining Drivers .....	68
Reset Top of Form to Factory Default .....	49	Installing Printer Drivers .....	68
Printer ON .....	49	Menu Mode .....	69
Printer OFF .....	49	Moving Through the Menu .....	70
Forms Tear-Off .....	50	Moving Forward .....	70
Changing the Forms Tear-Off Setting .....	51	Moving Backward .....	70
Automatic Forms Tear-Off .....	52	Resetting Menu to Factory Defaults .....	71
TEAR Key and Automatic Forms Tear-Off .....	53	Printing the Menu Settings .....	71
Manual Forms Tear-Off .....	54	Changing the Menu Settings .....	72
TEAR Key .....	55	Menu Settings Table .....	73
Forms Tear-Off set OFF .....	55	Explanations of Menu Items .....	78
Forms Tear-Off set ON .....	55	<b>Maintenance .....</b>	<b>81</b>
Paper Park .....	56	Replacing the Ribbon Cartridge .....	81
Changing Paper Paths .....	57	Printer Cleaning .....	82
Continuous-forms to single-sheet feed .....	57	Paper Jams .....	83
Single-sheet feed to continuous forms .....	57		
Printhead Gap .....	58		
Expanded Printhead Gap .....	59		
Print Quality .....	63		
Super Speed Draft .....	64		

<b>Troubleshooting .....</b>	<b>88</b>
General Information .....	88
Internet Support .....	88
List of Problems .....	89
Problem 1:	
My word processor files do not print the way I have the menu and front panel set. ....	90
Problem 2:	
Nothing happens when I turn on the printer. ....	91
Problem 3:	
The printer does not print when the computer sends data. ....	91
Problem 4:	
I'm getting strange symbols, incorrect fonts, etc., when I try to print a document. ....	91
Problem 5:	
Ink smears on the paper when I print on narrow forms. ..	92
Problem 6:	
I've installed a new ribbon and the printing is smeared and streaked. ....	92
Problem 7:	
The ALARM light is flashing. ....	92

Problem 8:	
The ALARM light is on and the Character Pitch 10 light is flashing. ....	92
Problem 9:	
The ALARM light is on and the Character Pitch 15 light is flashing. ....	93
Problem 10:	
The printer needs paper, but the ALARM light is not on and I cannot load the paper. ....	93
Problem 11:	
The Print Quality and Character Pitch keys on the front panel don't work. ....	93
Problem 12:	
Continuous-form paper sticks to the paper separator. ....	94
Problem 13:	
Nothing happens when I print to the parallel port. ....	94

<b>Specifications .....</b>	<b>95</b>	<b>Warranty, Regulatory, and Safety Information</b>	<b>118</b>
<b>Service and Support .....</b>	<b>100</b>	Limited Warranty: United States and Canada .....	118
General Information .....	100	Limited Warranty: Latin America .....	120
Documentation .....	101	Service and Support: United States and Canada .....	121
Purchase Location .....	101	Sales and Service Dealers: United States and Canada .	121
Internet Support .....	102	Telephone Support: United States and Canada .....	122
www.okidata.com .....	102	Service and Support: Latin America .....	123
my.okidata.com .....	102	Sales and Service Centers: Latin America .....	123
Telephone Support .....	103	Customer Support Professionals: Latin America .....	123
Service Centers .....	104	Oki Data on the Internet .....	124
Service and Support: United States and Canada .....	105	www.okidata.com .....	124
Service and Support: Latin America .....	106	my.okidata.com .....	124
<b>Accessories .....</b>	<b>107</b>	Oki Data Service Centers .....	125
Purchasing Accessories .....	107	Material Safety Data Sheet (MSDS) .....	126
Accessories: Part Numbers .....	108	Emergency Information: MSDS .....	126
Consumables: Part Numbers .....	108	Safety Information .....	130
Options: Part Numbers .....	108	Regulatory Information .....	131
Replacement Parts: Part Numbers .....	109	Year 2000 Compliance .....	131
Documentation .....	110	Energy Star® .....	131
<b>Printer Control Codes .....</b>	<b>111</b>	Federal Communications Commission (FCC) .....	132
Epson FX Commands .....	112	Industry Canada (IC) .....	133
IBM Proprinter III Commands .....	114	European Union Council of the European Communities	134
Oki Data MICROLINE Standard Commands .....	116	<b>Index .....</b>	<b>135</b>

# Helpful Hints

Your printer has many features and capabilities that will help you

- save money
- save time
- operate the machine

This section summarizes the features and capabilities directly connected to saving money and time.

Details for these features and capabilities are provided in other sections of this document.

You may want to use some of our Helpful Hints when working with your machine.



## Saving Money

### Saving Money: Forms Tear-Off

The Forms Tear-Off feature allows a printed page (rear feed, continuous form) to be torn off without wasting paper or adjusting the printer.

Forms Tear-Off automatically moves the paper from the initial printing position (print start position) to the tear-off position, after a time interval (which you select through the menu).

The top of the page (perforation) is even with the tear bar. The tear bar is located under the clear top of the access cover.

Paper remains in the tear-off position until the printer receives more data. Then, the paper moves back down for printing (retracts to the initial print position).

When printing stops, the paper will advance to the tear-off position.

This feature is normally turned off.

Forms Tear-Off and the Top of Form settings interact.

For more information, refer to “Using Your Printer, Forms Tear-Off” and “Using Your Printer, Top of Form.”

### Saving Money: Draft Mode

When printing drafts of documents, use either the High Speed Draft or Super Speed Draft mode. These modes use less ink than the Utility or Near Letter Quality Modes, thus extending the life of your ribbon. The draft modes also print at high speeds, reducing the time required to complete a print job.

For more information, refer to “Using Your Printer, Print Quality.”

## **Saving Time**

### **Saving Time: Internet Support**

Oki Data provides support via the Internet.

Oki Data's main web site, [www.okidata.com](http://www.okidata.com), is the gateway to Oki Data's products and services.

[my.okidata.com](http://my.okidata.com) is a powerful area of Oki Data's web site designed to help you personalize the information and service you get from Oki Data.

You can find information at your convenience, at any time.

For more information, refer to "Service and Support, Internet Support."

### **Saving Time: Draft Mode**

When printing drafts of documents, use either the High Speed Draft or Super Speed Draft mode. The draft modes print at high speeds, reducing the time required to complete a print job. These modes also use less ink than the Utility or Near Letter Quality Modes, thus extending the life of your ribbon.

For more information, refer to "Using Your Printer, Print Quality."

### **Saving Time: Paper Park**

Your printer's paper park feature allows you to print a single sheet (cut-sheet) page without removing continuous feed paper from the printer.

For more information, refer to "Using Your Printer, Paper Park."

### **Saving Time: Moving Through the Menu**

When the printer is in Menu Mode, you can move forward or backwards through the menu.

To move forward, press GROUP, ITEM, or Set, whichever is appropriate.

To move backward, press and hold SHIFT, then GROUP, ITEM, or Set, whichever is appropriate.

For more information, refer to "Using Your Printer, Menu Mode."

# Operation Tips

## Operation Tip: Top of Form

- ! *If you turn the platen knob when the printer is turned on, you will cause the Top of Form to mis-align. Always turn the printer off before turning the platen knob!*
- ! *Always determine the status of the Forms Tear-Off menu setting BEFORE setting the Top of Form. Refer to “Using Your Printer, Top of Form, Forms Tear-Off Status (ON or OFF).”*

Top of Form sets the print start position for the printer. It is adjustable in increments of 1/144 of an inch. The amount of adjustment is limited to avoid paper jams.

The Top of Form may be left at the factory default (1 inch), changed for a single print job, or set to a new (permanent) default.

The first line prints at the red line of the plastic paper shield (1) on the printhead.

The Top of Form and Forms Tear-Off settings of your printer interact.

How you set the Top of Form depends on the status of the Forms Tear-Off menu setting.

For more information, refer to “Using Your Printer, Top of Form (TOF).”

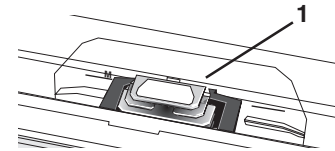

## Operation Tip: Turning the Platen Knob

- ! *If you turn the platen knob when the printer is turned on, you will cause the Top of Form to mis-align. Always turn the printer off before turning the platen knob!*

## Operation Tip: Using the Parallel Port

- ! *If you want to use the parallel port, you **MUST** remove the Network Card from the printer.*

*See the OkiLAN 6120e User's Guide for details.*

## Operation Tip: Control Access to the Printer

You can control access to the printer by changing the setting for the Operator Panel Function (in the Menu).

When the Operator Panel Function is set to Full Operation (the factory default), all keys on the front panel operate.

When the Operator Panel Function is set to Limited Operation, the PRINT QUALITY and CHARACTER PITCH keys don't work. This prevents these settings from being changed from the control panel when several people are using the printer.

For more information, refer to "Using Your Printer, Menu Mode, Menu Settings Table, Setup, Operator Panel Function."

# Introduction

Thank you for purchasing this printer.

This rugged 9-pin network printer can meet the needs of harsh and demanding environments. The expanded printhead gap, zero-tear capability, and multiple paper feed paths allow the printer to handle a wide variety of media, including 6-part forms. Your printer will provide years of dependable and efficient service.

In addition to the many standard features, options can expand the machine's capabilities.

For information on the options, see "Accessories."

## Oki Data on the Internet

The Oki Data Web Sites provide the most current information available on your product.

An on-line version of this document is available for viewing and downloading via Oki Data's Web Sites.

You may reach Oki Data via the Internet at:

- [www.okidata.com](http://www.okidata.com)
- [my.okidata.com](http://my.okidata.com)

For more information on the Oki Data Web Sites, refer to "Service and Support, Internet Support."

## Printer Features

- Super reliable, durable operation: 10,000 hours Mean Time Between Failures (MTBF)!
- Expandable head gap for handling forms up to 0.031" (0.79 mm) thick through the bottom feed path using the optional push and/or pull tractor.
- Advanced paper handling, with built-in rear push tractor and zero-tear forms capability.
- Blazing print speeds:
  - 300 characters per second (cps) in Utility mode
  - 390 cps in High Speed Draft (HSD) mode
  - 435 cps in Super Speed Draft (SSD) mode

# Parts Identification

The parts identified here are parts of the unit that you will use during normal operation.

For accessories (consumables, options, replacement parts, and documentation), refer to “Accessories.”

## Printer Serial Number

The serial number of your machine is on a label on the back of your machine.

The label says “S/N.”

An example serial number is: 401A0154693.

- ! ***You will need your printer serial number if your machine requires servicing.***

***A written receipt for the product, showing the date of purchase, dealer’s name, and both the model and serial numbers of the product must accompany any request or claim for work to be performed under Limited Warranty.***

## Parts Identification: Rear Feed (Continuous Forms)

- 1 Paper Guides
- 2 Paper Separator
- 3 Paper Lever
- 4 On-Off Switch
- 5 Platen Knob
- 6 Control Panel
- 7 Acoustic Cover
- 8 Access Cover

- ! *Move the paper lever to the position marked “REAR.”*
- *For rear feed, the paper lever is towards the front of the printer.*

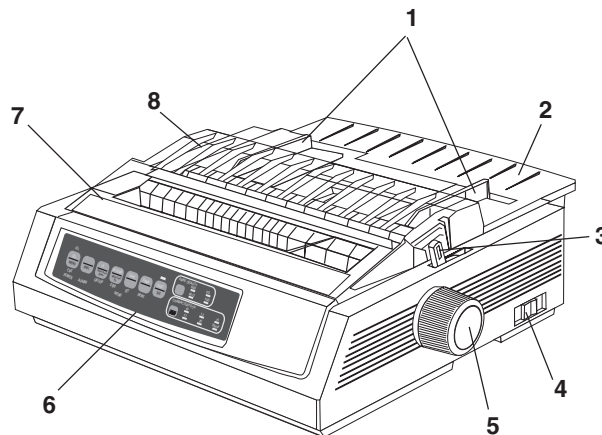



## Parts Identification: Top Feed (Single-Sheet)

- 1 Paper Guides
- 2 Paper Separator
- 3 Paper Lever
- 4 On-Off Switch
- 5 Platen Knob
- 6 Control Panel
- 7 Acoustic Cover (open)
- 8 Access Cover

- ! *Move the paper lever to the position marked “TOP.”*
- *The paper lever is towards the back of the printer.*

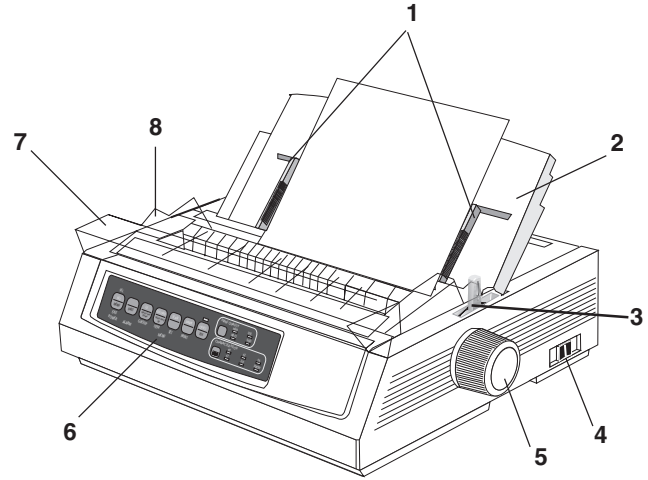

# Front Panel Lights

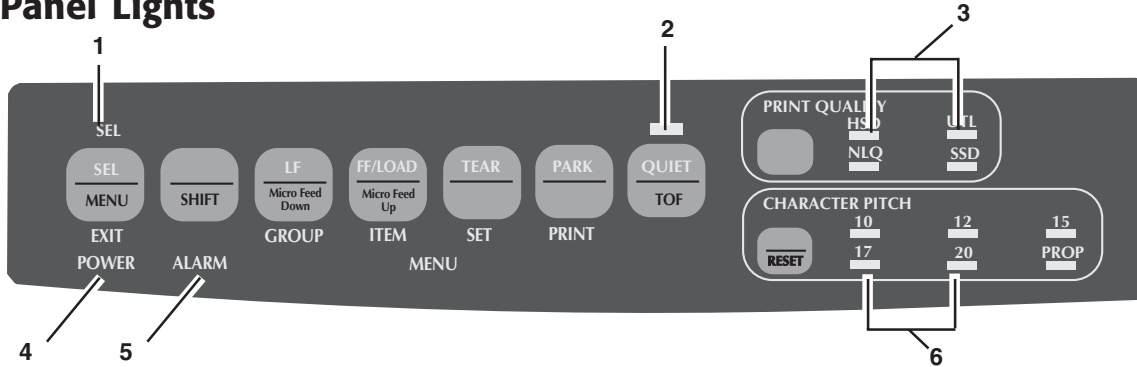

- 1 **SEL:** Glows = printer selected, ready to receive data  
Flashes = printer in Print Suppress Mode  
Not lit = printer deselected (cannot receive data)
- 2 **QUIET:** Glows = printer is in Quiet state.
- 3 **HSD / UTL / NLQ / SSD:** Indicate print quality selected.
- 4 **POWER:** Glows = printer is turned on.
- 5 **ALARM:** Glows = error condition exists:
  - out of paper (no other lights blinking)
  - paper jam if 15 cpi light is also blinking
  - paper lever is set to wrong position if 10 cpi light is also blinking.
  - Blinks = error condition. Turn printer off, then on; if light still flashes, contact service dealer.
- 6 **10 / 12 / 15 / 17 / 20 / PROP:**  
Indicate selected character pitch.

# Front Panel Keys

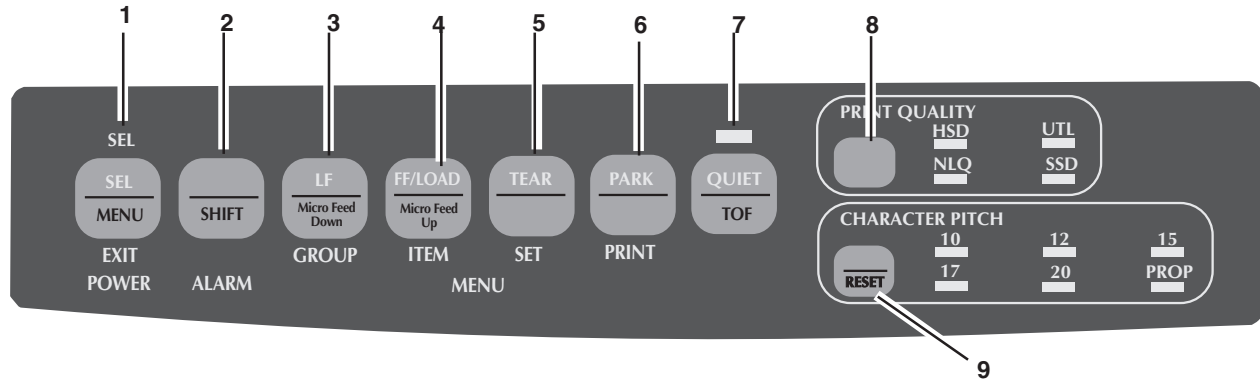

- 1 SEL: Selects/deselects printer (printer on-line / off-line). When held on power up, or with SHIFT key, engages Menu Mode.
- 2 SHIFT: Press and hold while pressing another key to engage the alternate function for that key (e.g., “Micro Feed Down” for LF key).
- 3 LF: Moves paper up one line; press and hold for repetitive line feeds. When held on power up, activates Font Test.
- 4 FF/LOAD: Loads/ejects single sheet of paper; loads continuous-form paper or feeds it to next page.
- 5 TEAR: Moves continuous-form paper up for tear-off or back down for printing.
- 6 PARK: Retracts continuous-form paper from the path.
- 7 QUIET: Turns Quiet Mode on and off. When held on power up, activates Rolling ASCII Test.
- 8 PRINT QUALITY: Selects print quality and font.
- 9 CHARACTER PITCH: Selects the character pitch. Used with SHIFT key to reset the printer and clear the buffer.

# Installation

## Installation Hints

- Read the setup and operating instructions in this document carefully. Be sure to save this document for future reference.
- Read and follow all warning and instruction labels on the printer itself.
- Place your printer on a firm, solid surface. If you put it on something unsteady, it might fall and be damaged. If you place it on a soft surface (such as a rug, sofa, or bed) the vents may be blocked, causing it to overheat.
- The printer must be installed near a power outlet which will remain easily accessible.
- The printer must be installed near a network outlet which will remain easily accessible.
- Be certain that your power source matches the rating listed on the back of the printer. If you are not sure, check with your dealer or with your local power company.
- Your printer has a grounded, 3-prong plug as a safety feature, and it will only fit into a grounded outlet. If you can not plug it in, chances are that you have an older, non-grounded outlet. Contact an electrician to have it replaced with a grounded outlet. Do not use an adapter to defeat the grounding.
- To avoid damaging the power cord, do not put anything on it or place it where it will be walked on. If the cord becomes damaged or frayed, replace it immediately.

- If you're using an extension cord or power strip with the printer, make sure that the total of the amperes required by all the equipment on the extension is less than the extension's rating. Generally, the total ratings of all equipment plugged into any one power line should not exceed 15 amperes. Don't exceed this unless you know that the power line your equipment is plugged into has a rating above 15 amperes.
- To protect your printer from overheating, make sure no openings on the printer are blocked. Do not put the printer on or near a heat source, such as a radiator or heat register. If you put the printer in any kind of enclosure, make sure it is well ventilated.

## Installation Overview

To install your printer, follow the instructions in this section. You must complete these steps for your printer to operate properly.

If you have purchased an option package for your printer, refer to the documentation you received with that option for installation instructions.

## Installation Location

- Place your printer on a firm, solid surface.
- Allow enough space on each side of the machine to easily access the platen knob and the various paper feed paths.
- Make sure a power outlet is available nearby.
- If you are using the network connection, make sure a network connection is available nearby.

## Customizing the Installation

Your printer has many settings (defaults) that do not need to be adjusted as part of a standard installation.

However, you may need to adjust settings to fit your standards.

Some settings you may need to adjust as part of your installation are:

- Top of Form (TOF)
- Paper Path
- Printhead Gap

To adjust these settings, refer to the appropriate section in “Using Your Printer.”

## Top of Form (TOF)

- ! *If you turn the platen knob when the printer is turned on, you will cause the Top of Form to mis-align. Always turn the printer off before turning the platen knob!*
- ! *The factory default setting for the Top of Form (where the printing should begin) is one inch down from the top of the page.*
- ! *Your software may print the first line of print above or below where TOF is set. You may need to adjust the TOF to meet your software's needs. Use the procedures in "Using Your Printer, Top of Form, Forms Tear-Off Status (ON or OFF)."*
- ! *The first line prints at the red line of the plastic paper shield (1) on the printhead.*

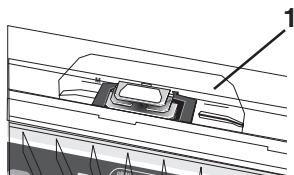

The Top of Form and Forms Tear-Off settings of your printer interact.

How you set the Top of Form depends on the status of the Forms Tear-Off menu setting.

If Forms Tear-Off is activated (set to ON), set the Top of Form using "Using Your Printer, Setting Top of Form, Forms Tear-Off ON (Step A)."

If Forms Tear-Off is NOT activated (set to OFF), set the Top of Form using "Using Your Printer, Setting Top of Form, Forms Tear-Off OFF (Step B)."

## Unpacking the Machine

Before you begin, be sure that all the items listed below are included in your package.

- ! *If any items are missing, contact your dealer immediately. Keep your packing materials and carton in case you ever need to ship or transport the unit.*

- 1 Printer
- 2 Ribbon Cartridge
- 3 Power Cord

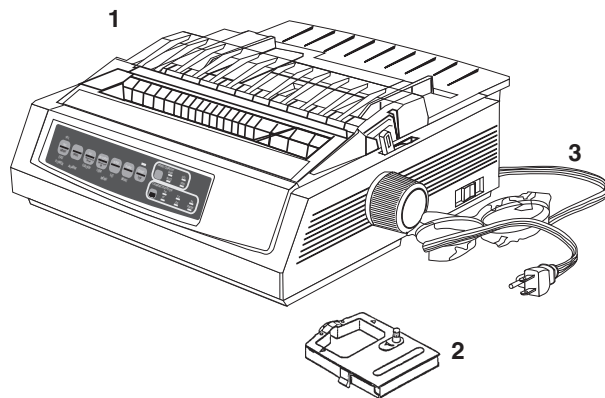



# Shipping Restraints

- 1 Open the access cover (1). Remove the printhead shipping restraint (2) and tape.

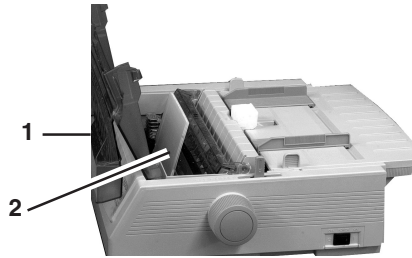

- 2 Grasp the tabs and lift off the paper separator (1). Remove the shipping restraint (2).

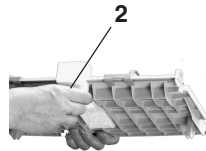
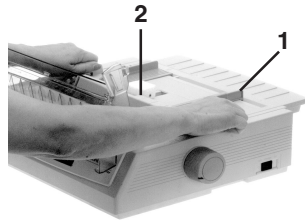

- 3 Install the paper separator.



- ! **Keep your packing materials and carton in case you ever need to ship or transport the unit.**

## Ribbon Cartridge

1 *Make sure the printer is turned OFF.*

2 Center the printhead (1).

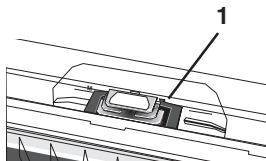

3 *If you are replacing the ribbon:* swing the front of the cartridge up off the printhead, then lift the cartridge out and discard it.

! **Caution!** *The printhead may be HOT!*

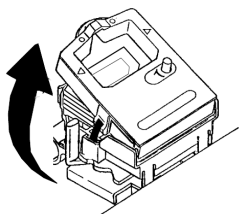

4 Unpack the ribbon cartridge.

! **Important!** *DO NOT remove the ribbon shield from the ribbon!*

1 Ribbon Shield

2 Grip Points

3 Take-up Knob

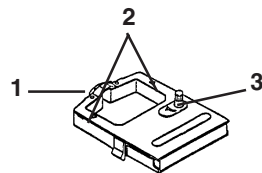

5 Install the new ribbon cartridge.

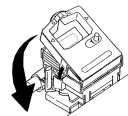

6 Turn the take-up knob in the direction of the arrow to take up any ribbon slack.

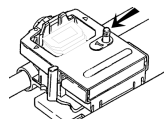

## Ribbon Cartridge Handling

- Leave unused ribbon cartridges in their packages until needed.
- When replacing a ribbon cartridge, re-use the packaging to dispose of the old ribbon cartridge.
- Be careful when removing the ribbon cartridge. Do not let it touch your clothing or porous materials. The ribbon ink may cause permanent stains.
- Ribbon ink on skin or clothing can usually be removed with soap and water.

## Ribbon Cartridge Emergency First Aid

### **Contact occurs with eyes.**

Flush eyes with large quantities of water for 15 minutes, keeping eyelids open with fingers. Seek medical attention.

### **Contact occurs with skin**

Wash thoroughly with soap and water.

### **For more information**

Refer to the Material Safety Data Sheet in “Warranty, Regulatory, and Safety Information.”

## Power Connections

- 1 *Make sure both the printer and the computer are OFF.*
- 2 Plug the power cord into the back of the printer (1), then into a grounded outlet (2).
- 3 Turn on the printer.

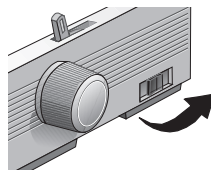
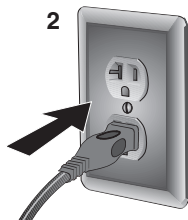
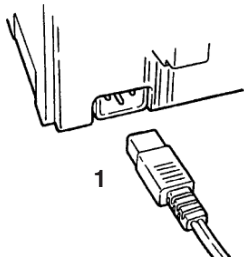

# Paper Loading

## Rear Feed, Continuous Forms

Use the rear-feed path for printing on single-thickness, continuous-form paper.

Use the single-sheet path (top feed) for graphics or charts.

! *If you have paper in the paper path, be sure to remove it before installing rear-feed paper.*

- 1 Lock Lever
- 2 Upper Tractor Cover
- 3 Pins
- 4 Lower Tractor Cover

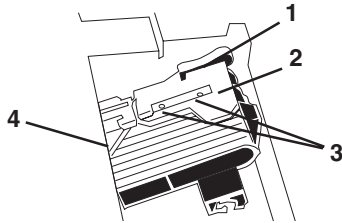

- 1 Move the paper lever to the position marked “REAR.”

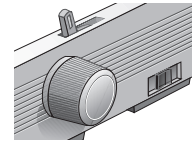

- 2 Grasp the tabs and lift off the paper separator.

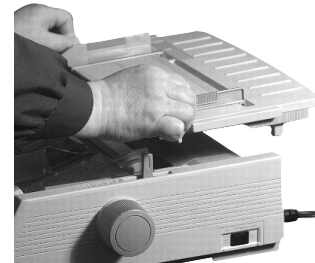

- 3 Pull up on the lock levers and open the tractor covers. Then, move the right tractor to fit the width of the paper.

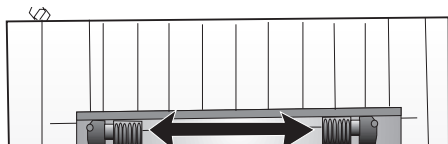

- 4 Place the first two holes in the paper over the tractor pins on either side. Close the tractor covers.



- 5 Move the left tractor to align the edge of the paper with the appropriate reference mark (1). Then, push back the lock lever.

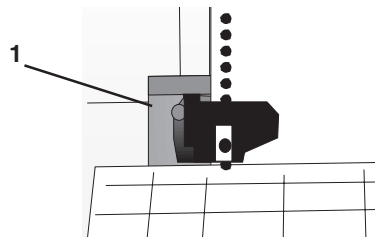

- 6 Adjust the position of the right tractor to center the holes in the paper on the pins. Then, push back the right lock lever.



- 7 Install the paper separator. Place the wire guide (1) on the pull-up roller assembly (2).

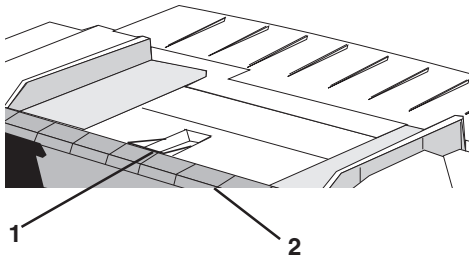

- 8 Press FF/LOAD. The paper feeds into the printer.

! **The factory default setting for the Top of Form (where the printing should begin) is one inch down from the top of the page. To change the setting, see “Using Your Printer, Top of Form (TOF).”**

## Top Feed (Single Sheets)

Use the single-sheet path for letterhead stationery, memos, and individual envelopes.

! **If you have continuous-form paper in the path, press**  
● **PARK to remove it before loading single sheets.**

- 1 Make sure the printer is on and deselected (SEL light off).
- 2 Place the paper lever in the position marked “TOP:”

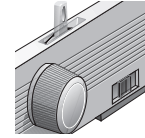

- 3 Open the carriage cover. Raise the paper separator to the single-sheet position.

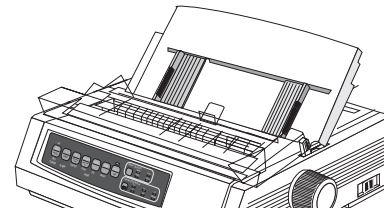

- 4 Make sure the wire feed guide (1) is secured in the sheet guide.

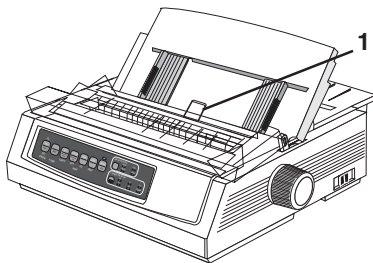

- 5 Adjust the paper feed guides (1) for the width of the paper. Place a sheet of paper in the separator. The paper will feed into the printer.

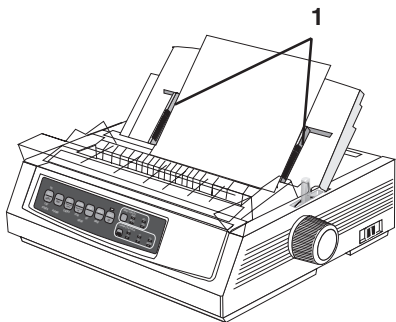

- ! **Important!**
- *If the paper does not feed in, remove it. Check the paper lever position. Make sure the ALARM light is on: if it is flashing, hold the SHIFT key and press the CHARACTER PITCH (RESET) key. Reload the sheet of paper.*
  - *The factory default setting for the Top of Form (where the printing should begin) is one inch down from the top of the page. To change the setting, see “Using Your Printer, Top of Form (TOF).”*



## Testing the Printer

Running the printer self tests is a good way to check the installation of your printer.

The two self tests are:

- Font Sample Test
- Rolling ASCII Test

- ! *Wide Carriage Model*
- *Microline 321 Turbo/n*

*If you are using 8.5 inch paper to run the test, make sure the paper width selection in the printer menu is set to 8.5 inches. Otherwise, printing on the platen may damage the printer. Refer to “Using Your Printer, Menu Mode, Explanations of Menu Items.”*

## Font Sample Test

### ! *Wide Carriage Model*

#### • *Microline 321 Turbo/n*

*If you are using 8.5 inch paper to run the test, make sure the paper width selection in the printer menu is set to 8.5 inches. Otherwise, printing on the platen may damage the printer. Refer to “Using Your Printer, Menu Mode, Explanations of Menu Items.”*

### ! *The Font Sample Test automatically stops after all the available fonts print.*

The Font Sample Test prints a sample of the fonts standard to the printer.

The top of the printout has the Printer Model, Emulation, Country Code, Interface, and Firmware Revision Level for your printer.

To run the test:

- Turn the printer off, then press and hold the LF key while turning the printer back on.



To exit the test:

- Press SEL.



## Rolling ASCII Test

### ! *Wide Carriage Model*

#### • *Microline 321 Turbo/n*

*If you are using 8.5 inch paper to run the test, make sure the paper width selection in the printer menu is set to 8.5 inches. Otherwise, printing on the platen may damage the printer. Refer to “Using Your Printer, Menu Mode, Explanations of Menu Items.”*

### ! *The Rolling ASCII Test DOES NOT automatically stop.*

#### • *You must manually stop it.*

The Rolling ASCII Print Test produces a continuous printout of all 96 ASCII characters in a rolling pattern. The type style set in the printer menu will be utilized.

Use the Rolling ASCII Test to check the following.

- Print Quality
  - Across the entire length of a line
  - Down the entire page
- Line Spacing
- Character Formation

The top of the printout has the Printer Model, Emulation, Country Code, and Firmware Revision Level.

To run the test:

- Turn the printer off. Then, press and hold the QUIET key while turning the printer back on.



To exit the test:

- Press SEL.



## Local Printer Installation

- ! You **MUST** install your printer as a Local Printer before you perform any network installation.

*During this part of your printer installation, you DO NOT connect a cable between your printer and your computer.*

*You are making an installation to a logical port, which is done through software, not physical connections.*

- ! If you want to use the parallel port, you **MUST** remove the Network Card from the printer. See the *OkiLAN 6120e User's Guide* for details.

## Installing Printer Software

### Windows 95, 98, Me, NT4.0

- 1 With the OKI ML 320/321 Turbo/n CD in your CD-ROM drive, click **Start**→ **Run**.
- 2 Browse to your CD-ROM drive, then double-click **install.exe**.
- 3 On the OKI Menu Installer main menu, click **Printer Software**.
- 4 Make sure that at least the ML320/1 Tn Driver is selected. Click **Next**.
- 5 Select **Local Printer**. Click **Next**.
- 6 Select **LPT1**. Click **Next**.
- 7 Click **Finish**.

## Installing Printer Software

### Windows 2000

- 1 With the OKI ML 320/321 Turbo/n CD in your CD-ROM drive, click **Start**→**Run**.
- 2 Browse to your CD-ROM drive, then double-click **install.exe**.
- 3 On the OKI Menu Installer main menu, click **Printer Software**. This launches the Add Printer Wizard.
- 4 Select **Local**. Clear **Automatically detect and install my Plug and Play printer**. Click **Next**.
- 5 Click **Next** to accept LPT1 as the port selection.
- 6 Click **Have disk**.
- 7 Click **Browse**.
- 8 Locate CD-ROM in the pull-down menu.
- 9 Open the **Win2k\English\** folder.
- 10 Select **OEMSETUP.INF**. Click **Open**.
- 11 Click **OK**.
- 12 **OKI ML320/1 Tn** displays in the Printers window. Click **Next**—*do not select **Have disk***.
- 13 Rename the printer if you wish. Click **Next**.
- 14 Select **Do not share this printer**. Click **Next**.
- 15 Do not print a test page. Click **Next**.
- 16 Click **Finish**.
- 17 If the Digital Signature Not Found window appears, click **Yes**.

## Network Printer Installation

- ! *You MUST install your printer as a Local Printer before you perform any network installation.*
- ! *If you want to use the parallel port, you MUST remove the Network Card from the printer. See the OkiLAN 6120e User's Guide for details.*

## Connecting the Network Cable

- 1 Plug the power adapter wire into the power jack on the OkiLAN 6120e. Then plug the power adapter into a 120 VAC wall outlet.
- ! *Some countries may require a different adapter for local voltages, such as 240 VAC.*

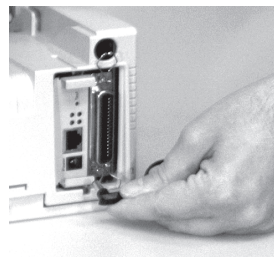

- 2 Attach the 10/100 Base-T UTP cable to the receptacle on the back of the OkiLAN 6120e. Attach the other end of the cable to the Network.

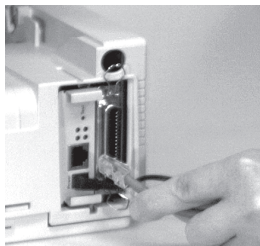

- 3 Plug the printer power cord into the power outlet.

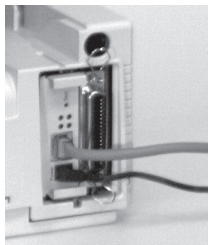

## Network Installation

For detailed information on installing network software and setting up your printer on a network, refer to the on-line OkiLAN 6120e User's Guide.

From the OKI Menu Installer, click **Network and Admin Software**→ **Network Documentation**.

## Connecting to the Parallel Port

! *If you want to use the parallel port, you **MUST** remove the Network Card from the printer. See the OkiLAN 6120e User's Guide for details.*

! *FCC regulations require the use of a shielded cable no longer than 6 ft. (1.8 m). An IEE 1284-compatible parallel cable is needed for bi-directional communications.*

- 1 Plug the interface cable into the parallel port (1) and secure it with the wire loops.

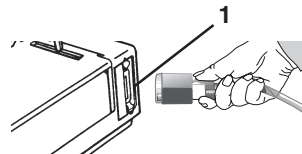

- 2 Attach the other end of the cable to your computer.



# Product Registration

## my.okidata.com

### Your Personal Solutions Center

Register your printer and create your own personalized support center with *my.okidata.com*.

*My.okidata.com* is a powerful new area of our web site designed to help you get the most from your OKI printer. It represents our commitment to providing you with solutions, finding out the latest updates about your OKI products, and getting the details on OKI programs and services that can help your bottom line.

You can also

- Choose to receive product updates via e-mail.
- Have private access to our solutions section.
- Check out the What's New section to see what's changed since your last visit.
- Get your own Solutions Specialist that you can contact directly via e-mail when you need assistance.

*my.okidata.com* offers you support, solutions and more, all personalized for you and your specific OKI printer. Start using *my.okidata.com* today!

## Registering Your Printer

You can register your printer by:

- visiting our website at <http://www.okidata.com>. Click on **Product Registration**.
- using the OKI Menu Installer (*PC Users*).
  - 1 Insert the OKI CD in your CD-ROM Drive.
  - 2 Browse to your CD-ROM drive and double-click INSTALL.EXE in the root directory. Click **OK**.
  - 3 Select the language and your printer model. Click **Continue**.
  - 4 When the OKI Menu Installer screen appears, click the **On-Line Registration** button.
- filling out the enclosed registration form and mailing it in  
or  
faxing it in.

## Service and Support

If you need further assistance or have questions, please refer to "Service and Support."

# Using Your Printer

## Top of Form (TOF)

- ! *If you turn the platen knob when the printer is turned on, you will cause the Top of Form to mis-align. Always turn the printer off before turning the platen knob!*
- ! *The factory default setting for the Top of Form (where the printing should begin) is one inch down from the top of the page.*
- ! *Your software may print the first line of print above or below where TOF is set. You may need to adjust the TOF to meet your software's needs. Use the procedures in "Using Your Printer, Top of Form, Forms Tear-Off Status (ON or OFF)."*

Top of Form sets the print start position for the printer. It is adjustable in increments of 1/144 of an inch. The amount of adjustment is limited to avoid paper jams.

The first line prints at the red line of the plastic paper shield (1) on the printhead.

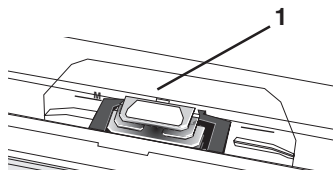

## Top of Form (TOF) and Forms Tear-Off

- ! *If you turn the platen knob when the printer is turned on, you will cause the Top of Form to mis-align. Always turn the printer off before turning the platen knob!*
- ! *Your software may print the first line of print above or below where TOF is set. You may need to adjust the TOF to meet your software's needs. Use the procedures in "Using Your Printer, Top of Form, Forms Tear-Off Status (ON or OFF)."*

The Top of Form and Forms Tear-Off settings of your printer interact.

How you set the Top of Form depends on the status of the Forms Tear-Off menu setting.

If Forms Tear-Off is activated (set to ON), set the Top of Form using Step A.

Refer to "Using Your Printer, Setting Top of Form, Forms Tear-Off ON (Step A)."

If Forms Tear-Off is NOT activated (set to OFF), set the Top of Form using Step B.

Refer to "Using Your Printer, Setting Top of Form, Forms Tear-Off OFF (Step B)."

## Forms Tear-Off Status (ON or OFF)

Before you set the Top of Form, you need to know the status of the Forms Tear-Off menu setting (whether it is ON or OFF). There are two ways to determine the status of the Forms Tear-Off menu setting:

- print the Menu.
- use the TEAR key.

To print the Menu, refer to "Using Your Printer, Menu Mode, Print the Menu Settings."

To use the TEAR key:

- 1 Load paper.
- 2 Press TEAR.
- 3 If the paper moves up, then Forms Tear-off is OFF.  
If the paper moves down, then Forms Tear-off is ON.

## Setting Top of Form, Forms Tear-Off ON (Step A)

- ! *If you turn the platen knob when the printer is turned on, you will cause the Top of Form to mis-align. Always turn the printer off before turning the platen knob!*
  - *Always determine the status of the Forms Tear-Off menu setting BEFORE setting the Top of Form. Refer to “Using Your Printer, Top of Form, Forms Tear-Off Status (ON or OFF).”*
- 1 Turn the printer ON.
  - 2 Park the paper.
  - 3 With paper out of the unit, (red alarm light should be on) press SHIFT (1) and QUIET/TOF (5) to reset the current Top of Form.
  - 4 Press FF/LOAD (3) to load the paper.
  - 5 Press SEL/MENU (6) to take the printer off line.  
The SEL light goes out.
  - 6 Wait until the paper moves up to the tear position, then press and hold TEAR (4).  
The paper moves to the current Top of Form.  
Keep pressing and holding TEAR.
  - 7 Press and hold SHIFT and release TEAR.

- 8 As you continue to hold SHIFT, press the LF / Micro Feed Down (2), or FF/LOAD / Micro Feed Up (3), depending on which direction you want to move the paper to align Top of Form.

Press LF / Micro Feed Down to decrease the space (move Top of Form higher). The paper moves down.

Press FF/LOAD / Micro Feed Up to increase the space (move Top of Form lower). The paper moves up.

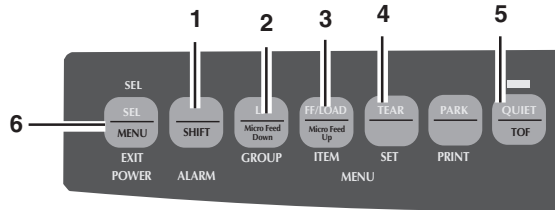

- ! *The first line prints at the red line of the plastic paper shield (7) on the printhead.*

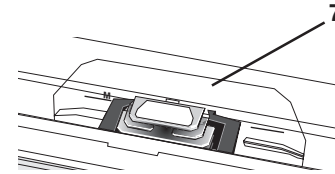

- 9 Keep holding SHIFT and press QUIET/TOF a few times to set the Top of Form.
- 10 When the Top of Form is at the correct position, release all keys.
- 11 Press SEL/MENU to place the printer on-line.

## Setting Top of Form, Forms Tear-Off OFF (Step B)

- ! *If you turn the platen knob when the printer is turned on, you will cause the Top of Form to mis-align. Always turn the printer off before turning the platen knob!*
- ! *Always determine the status of the Forms Tear-Off menu setting BEFORE setting the Top of Form. Refer to “Using Your Printer, Top of Form, Forms Tear-Off Status (ON or OFF).”*

- 1 Turn the printer ON.
- 2 Press SEL/MENU (6) to take the printer off line. The SEL light goes out.
- 3 Press and hold SHIFT (1).  
Then, press LF / Micro Feed Down (2) or FF/LOAD / Micro Feed Up (3), depending on which direction you want to move the paper to align the tear-off position.

Press LF / Micro Feed Down to decrease the space (move Top of Form higher). The paper moves down.

Press FF/LOAD / Micro Feed Up to increase the space (move Top of Form lower). The paper moves up.

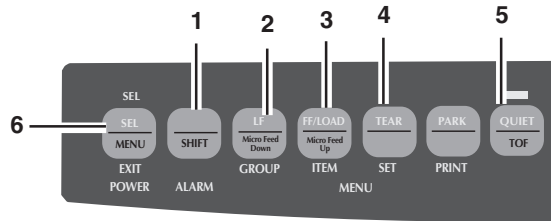

- ! **The first line prints at the red line of the plastic paper shield (7) on the printhead.**

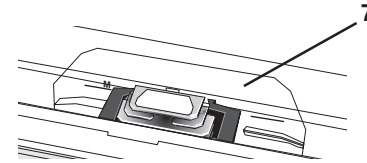

- 4 Keep holding SHIFT and press QUIET/TOF a few times to set the Top of Form.
- 5 When Top of Form is at the correct position, release all keys.
- 6 Press SEL/MENU to place the printer on line.

- ! **If you turn the platen knob when the printer is turned on, you will cause the Top of Form to mis-align. Always turn the printer off before turning the platen knob!**
- ! **For information on resetting the Top of Form to the factory default, refer to “Using Your Printer, Top of Form, Reset Top of Form to Factory Default.”**

## Temporary Top of Form Change

- ! *If you turn the platen knob when the printer is turned on, you will cause the Top of Form to mis-align. Always turn the printer off before turning the platen knob!*
- ! *The factory default setting for the Top of Form (where the printing should begin) is one inch down from the top of the page.*

To change the Top of Form (move it lower) *for one page only*:

- 1 Press SEL to deselect the printer.
- 2 Press LF to change the position of the Top of Form.



## Reset Top of Form to Factory Default

- ! *If you turn the platen knob when the printer is turned on, you will cause the Top of Form to mis-align. Always turn the printer off before turning the platen knob!*
- ! *The factory default setting for the Top of Form (where the printing should begin) is one inch down from the top of the page.*

There are two ways to reset the Top of Form to the factory default:

- with the printer ON.
- with the printer OFF.

### Printer ON

- 1 With the printer ON, and paper parked (out of the printer) Press QUIET / TOF.

### Printer OFF

- 1 With the printer OFF, and no paper installed, Press and hold PARK + QUIET/TOF while turning on the printer.

## Forms Tear-Off

- ! *The status of the Forms Tear-Off menu setting affects how you set the Top of Form.*

*To determine the status of the Forms Tear-Off menu setting, refer to “Using Your Printer, Top of Form, Forms Tear-Off Status (ON or OFF).”*

*For information on setting the Top of Form, refer to “Using Your Printer, Top of Form, Setting Top of Form, Forms Tear-Off (ON or OFF).”*

The Forms Tear-Off feature allows a printed page (continuous forms, rear or bottom feed, with no pull tractor option installed) to be torn off without wasting paper or adjusting the printer.

Forms Tear Off automatically moves the paper from the initial printing position to the tear-off position, after a time interval (which you select through the menu).

The top of the page (perforation) is even with the tear bar. The tear bar is located under the clear top of the access cover.

Paper remains in the tear-off position until the printer receives more data. Then, the paper moves back down for printing (retracts to the initial print position).

When printing stops, the paper advances to the tear-off position.

The default setting for Forms Tear-Off is OFF.

There are two types of Forms Tear-Off:

- Automatic Forms Tear-Off
- Manual Forms Tear-Off

- ! *If the software package you are using “pauses” while sending data to the printer, Forms Tear-Off may be activated (if it is enabled through the Menu). The pause must be for two or more seconds. No data is lost. Uneven print registration will occur due to the paper movement. If the problem occurs, use the menu to turn off this feature.*

- ! *DO NOT use Forms Tear-Off with labels or multi-part forms!*

- ! *Forms Tear-Off CANNOT be used when the optional pull tractor is engaged.*

## Changing the Forms Tear-Off Setting

The default setting for Forms Tear-Off is OFF.

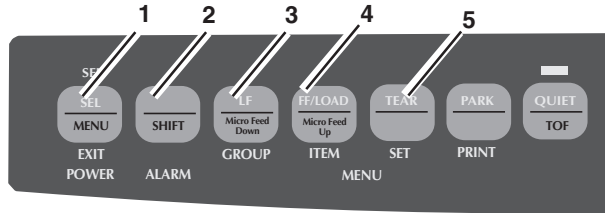

To change the Forms Tear-Off setting:

- 1 Press SEL (1) + SHIFT (2).
- 2 Press GROUP (3) until one of the following lines appears, depending on which paper feed you are using  
REAR FEED            Form Tear-Off    OFF  
BOTTOM FEED        Form Tear-Off    OFF
- 3 Press ITEM (4) until Form Tear-Off appears in the second column.
- 4 Press SET (5) until the time interval you wish to select appears in the third column.
- 5 Press SEL (1) + SHIFT (2) to exit Menu Mode and save the setting.

- ! *The status of the Forms Tear-Off menu setting affects how you set the Top of Form.*
- ! *If the software package you are using “pauses” while sending data to the printer, Forms Tear-Off may be activated (if it is enabled through the Menu). The pause must be for two seconds or more. No data is lost. Uneven print registration will occur due to the paper movement. If the problem occurs, use the menu to turn off Forms Tear-Off.*
- ! *DO NOT use Forms Tear-Off with labels or multi-part forms!*
- ! *Forms Tear-Off CANNOT be used when the optional pull tractor is engaged.*

## Automatic Forms Tear-Off

Forms Tear-Off must be set to ON in the menu for Automatic Forms Tear-Off to occur.

Automatic Forms Tear-Off automatically moves the paper from the initial printing position (print start position) to the tear-off position, after a time interval which you select through the menu.

The top of the page (perforation) is even with the tear bar. The tear bar is located under the clear top of the access cover.

Paper remains in the tear-off position until the printer receives more data. Then, the paper moves back down for printing (retracts to the initial print position).

When printing stops, the paper advances to the tear-off position.

- ! *The status of the Forms Tear-Off menu setting affects how you set the Top of Form.*

*To determine the status of the Forms Tear-Off menu setting, refer to “Using Your Printer, Top of Form, Forms Tear-Off Status (ON or OFF).”*

*For information on setting the Top of Form, refer to “Using Your Printer, Top of Form, Setting Top of Form, Forms Tear-Off (ON or OFF).”*

- ! *If the software package you are using “pauses” while sending data to the printer, Forms Tear Off may be activated (if it is enabled through the Menu). The pause must be for two or more seconds. No data is lost. Uneven print registration will occur due to the paper movement. If the problem occurs, use the menu to turn off this feature.*
- ! *DO NOT use Forms Tear Off with labels or multi-part forms!*
- ! *Forms Tear-Off CANNOT be used when the optional pull tractor is engaged.*

## TEAR Key and Automatic Forms Tear-Off

If you press TEAR (1) when Forms Tear-Off is turned on (activated in the printer menu), the printer retracts the paper to the Top of Form position.

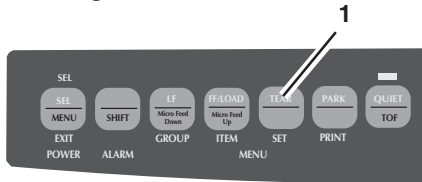

## Manual Forms Tear-Off

Manual Forms Tear-Off allows you to advance a single page to the tear-off position.

Manual Forms Tear-Off works when Forms Tear-Off is turned off (deactivated in the printer menu).

When Forms Tear-Off is turned on (activated in the printer menu), and you attempt Manual Forms Tear-Off, the printer retracts the paper to the Top of Form position.

! ***DO NOT use Forms Tear-Off with labels or multi-part forms!***

! ***Forms Tear-Off CANNOT be used when the optional pull tractor is engaged.***

- 1 Press TEAR (1) to advance continuous-form paper up to the tear position.

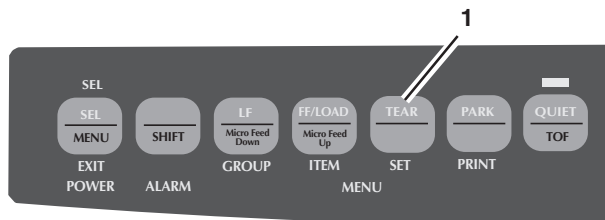

# TEAR Key

## Forms Tear-Off set OFF

If you press TEAR (1) when Forms Tear-Off is turned off (deactivated in the printer menu), the printer advances continuous-form paper up to the tear position.

Manual Forms Tear-Off allows you to advance a single page to the tear-off position.

Manual Forms Tear-Off works when Forms Tear-Off is turned off (deactivated in the printer menu).

! **Forms Tear-Off CANNOT be used when the optional pull tractor is engaged.**

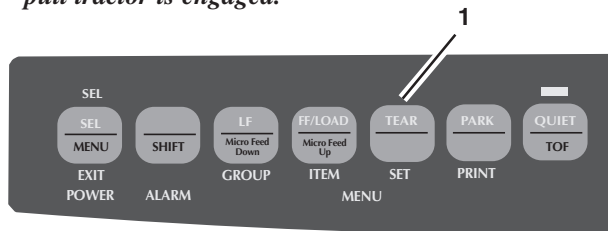

## Forms Tear-Off set ON

If you press TEAR (1) when Forms Tear-Off is turned on (activated in the printer menu), the printer retracts the paper to the Top of Form position.

! **Forms Tear-Off CANNOT be used when the optional pull tractor is engaged.**

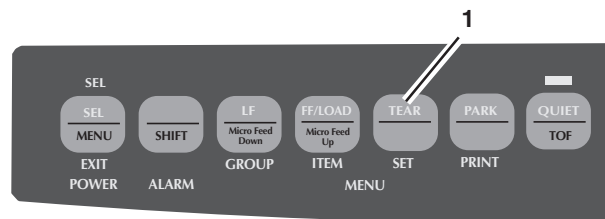

## Paper Park

! *Never park labels!*

Paper park allows you to print a single sheet (cut-sheet) page without removing continuous feed paper from the printer.

Press PARK (1) to retract rear-feed paper from the paper path.

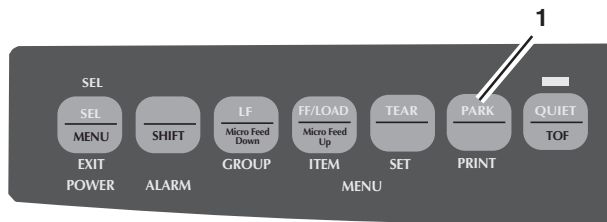



# Changing Paper Paths

## Continuous-forms to single-sheet feed

- 1 Tear off any printed pages.
- 2 Press PARK.
- 3 Raise the paper separator to the single-sheet feed position.
- 4 Place the wire feed guide in the paper separator.
- 5 Move the paper lever to the position marked “TOP.” The paper lever is towards the back of the printer.
- 6 Place a sheet of paper in the paper separator.

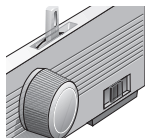

## Single-sheet feed to continuous forms

- 1 Press FF/LOAD to remove the single-sheet paper.
- 2 Lower the paper separator into the continuous-forms position. Swing the wire feed guide over onto the pull-up roller.
- 3 Move the paper lever to the appropriate position  
For rear feed (1), the paper lever is towards the front of the printer.  
For bottom feed, (2), the paper lever is in the center position.
- 4 If necessary, load continuous-form paper.
- 5 Press FF/LOAD.

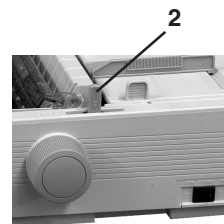
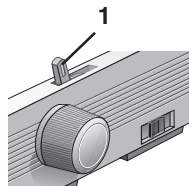

## Printhead Gap

The printhead gap is the distance between the printhead and the platen.

- ! **Make sure the printer is turned off before you open the access cover.**
- **access cover.**

To adjust the gap, open the access cover and move the blue lever (1) to the recommended setting from the table.

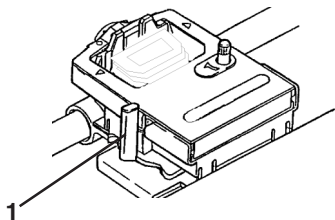

Media	Setting
12-20 lb paper	1
20-24 lb bond paper	2
Labels	3 or 4
Envelopes	4 or 5
2-part form (with carbon)	1 or 2
3-part form (with carbon)	2 or 3
4-part form (with carbon)	3 or 4
5-part form (with carbon)	4 or 5
6-part form (with carbon)	5

- ! **For dedicated, bottom-feed printing of extra-thick continuous forms (requires optional push and/or pull tractor), the printhead gap range can be expanded to take forms up to 0.031" (0.79 mm) thick. For more information, refer to "Using Your Printer, Printhead Gap, Expanded Printhead Gap."**

## Expanded Printhead Gap

Your printer can be used for dedicated bottom-feed printing on extra-thick multi-part forms. Extra-thick multi-part forms range from 0.017-inch (0.43 mm) to a maximum of 0.03 inch (0.79 mm). To print on extra-thick multi-part forms, you engage the expanded printhead gap feature. This expands the head gap settings for extra-thick forms and heavy card stock. It also increases the impact strength of the pins in the printhead.

- ! **CAUTION!** *Once the expanded printhead gap is engaged, you cannot print on single sheets without changing the gap back. If you try to print on single sheets without adjusting the printhead gap, you can damage the printhead and void your warranty. To disengage the expanded printhead gap, reverse the following steps.*

To engage the expanded printhead gap:

- 1 Turn the printer off.
- 2 Remove the access cover and the pull-up roller assembly.

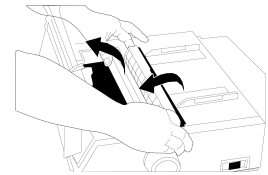
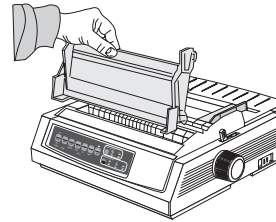

- 3 Move the printhead to the center of the platen.
- 4 Remove the ribbon cartridge.

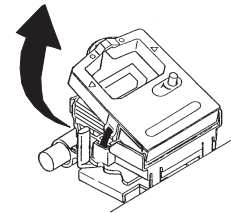

- 5 Swing up the printhead clamp, then remove it by pushing forward (toward the platen) and to the left.

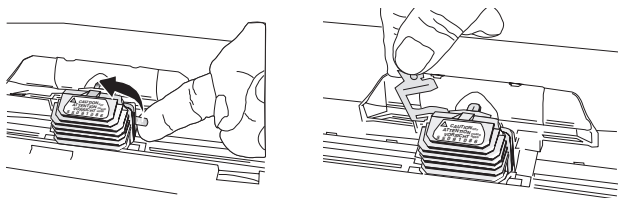

- 6 Remove the printhead.

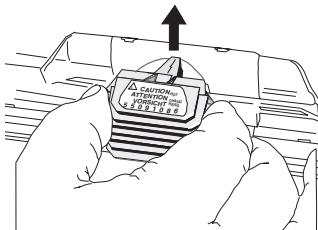

- 7 Lift the printhead plate off the carriage assembly (1).

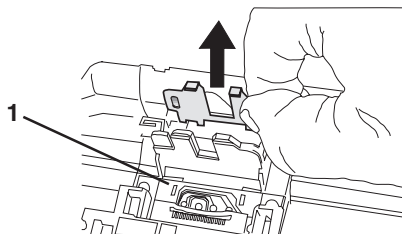

- 8 Turn the printhead plate around and reinsert it on the other side of the carriage assembly (1).

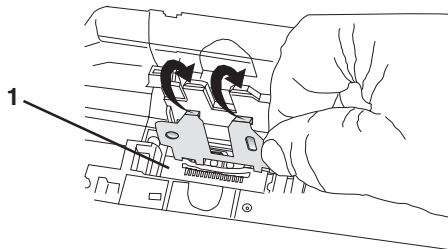

- 9 Replace the printhead, making sure that the circuit board at the bottom of the printhead firmly engages the slot (1) in the carriage.

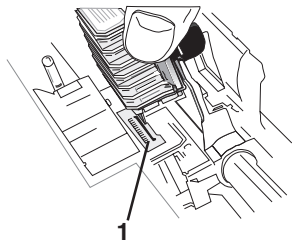

- ! **CAUTION!** Be sure the printhead is fully inserted before proceeding.

- 10 Reinstall the printhead clamp and swing it back over to lock the printhead in place.

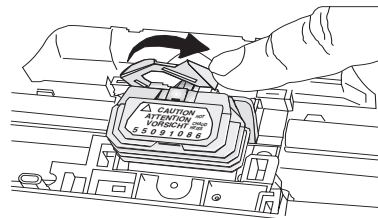

- ! **Important!** The clamp must be between the black projection on the printhead and the metal plate on the carriage, on both sides.

**11** Reinstall the ribbon cartridge.

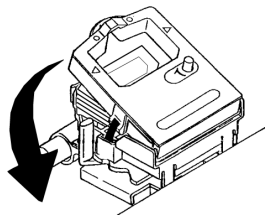

**12** Replace the pull-up roller assembly and the access cover, then turn the printer on.

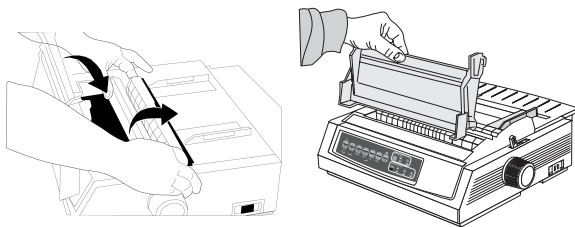

**13** Change the printer's secondary menu (make sure paper is loaded!) to engage the expanded printhead gap:

- a) Press SEL + TEAR while turning the printer back on.
- b) Press LF to advance through the menu to the Technical group (last option in menu).
- c) Press FF/LOAD to advance through the items to Expanded Gap.
- d) Press TEAR to change the setting for Expanded Gap to Valid.
- e) Press SHIFT + MENU to exit the menu and save your setting.

## Print Quality

- ! **Important!**
- *Front panel settings for print quality and character pitch are overridden by software commands. The lights will always reflect the printer's state.*



Press PRINT QUALITY to select:

### **NLQ: Near Letter Quality**

- Highest quality, slowest speed
- Courier or Gothic fonts
- Recommended for correspondence

### **UTL: Utility**

- Medium quality, medium speed
- Gothic font only
- Recommended for internal documents and high-volume data.

### **HSD: High Speed Draft**

- Lower quality, faster speed
- Gothic font only
- Recommended for drafts.

### **SSD: Super Speed Draft**

- Lowest quality (12 cpi only), fastest speed
- Gothic font only
- Recommended for fastest output of drafts.

## Super Speed Draft

To use Super Speed Draft (SSD), enter the Menu Mode and make changes as follows:

- 1 Press SHIFT + SEL.
- 2 Press GROUP twice.
- 3 Press SET until DRAFT prints as the setting for the Print Mode.
- 4 Press ITEM.
- 5 Press SET (SSD prints).
- 6 Press SHIFT + SEL to exit Menu Mode and save your changes.

## Printer Reset

When you reset the printer, you reinitialize it.

You will need to reset the printer to clear some error conditions

To reset the printer:

- 1 Press and release the SEL key to take the printer off-line. The SEL light will be out.
- 2 Then, press and hold the SHIFT key and press the RESET (CHARACTER PITCH) key.
- 3 The printer is reset.



### ***Important!***

- ***A printer reset is NOT the same as a reset to factory defaults.***

***A printer reset reinitializes the printer, but does NOT affect any menu settings.***

***A reset to factory defaults returns ALL menu settings to the factory defaults.***



# Character Pitch

Press CHARACTER PITCH/RESET to select the width of characters in characters per inch, or Proportional.

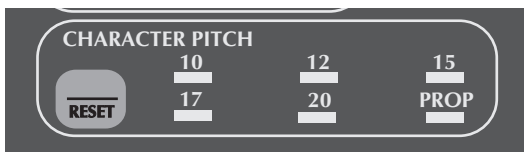

## 10 cpi

- Recommended for standard text
- Not available for SSD

## 12 cpi

- Recommended for standard text
- Yields more text per page

## 15 cpi

- Recommended for spreadsheets
- Yields more text per page

## 17.1 cpi, 20 cpi

- Recommended for spreadsheets
- Smallest print
- Not available for SSD

## PROP

- Recommended for a more polished appearance
- Proportional spacing
- NLQ and Utility only

# Emulations

## Available Emulations

Your printer has three emulations:

- Epson® FX (ESC/P)
- IBM® Proprinter III (PPSII) — *factory setting*
- OKIDATA® MICROLINE® Standard

## Changing Emulations

- 1 Make sure paper is loaded.
- 2 Press SHIFT + SEL. The printer enters the Menu Mode.
- 3 Press LF. The following line prints:  
Printer Control Emulation Mode IBM  
PPR
- 4 Press TEAR consecutively until the emulation you wish to select prints in the right-hand column.
- 5 Press SHIFT + SEL to save your setting and exit the Menu Mode.

# Printer Drivers

## Selecting Printer Drivers

Before you can use your printer, you must select the correct printer driver in your software. If you select the wrong driver, you will see strange characters, incorrect fonts, etc.

- ! *See your software documentation for information on*
- *how to select a printer driver.*

The drivers below are listed by **decreasing** compatibility with your printer. *Use one as close to the top of the list as possible.*

### **Epson FX**

Oki Data ML320/1T Epson

Oki Data ML320/1 Epson

Epson FX286e

Epson FX 850/1050

Epson FX 800/1000

Epson FX

### **IBM Proprinter III**

Oki Data ML320/1T IBM

Oki Data ML320/1 IBM

IBM Proprinter III

IBM Proprinter II

IBM Proprinter

IBM Graphics Printer

### **Oki Data Microline Standard**

Oki Data Microline 320/321T

Oki Data Microline 320/321

Oki Data Microline 520/521

Oki Data Microline 292/293

Oki Data Microline 192/193

## Obtaining Drivers

The driver included on the MICROLINE 320/321 Turbo/n CD-ROM is an IBM Proprinter II driver for use with Windows operating systems.

Drivers are available for a variety of operating systems.

You can obtain the drivers by downloading them from the web site at

**<http://www.okidata.com>**

## Installing Printer Drivers

Installation procedures vary according to the driver you select. Follow the instructions provided with the selected driver.

## Menu Mode

- ! **ALWAYS print the current Menu Mode settings before you reset or change the Menu settings.**
- **Printing the settings is the only way to have a record of the settings.**

*To print the Menu Mode Settings, refer to “Using Your Printer, Menu Mode, Printing the Menu Settings.”*

In Menu Mode, you use the front panel keys to change the defaults for the printer parameters. The changes you make in the Menu Mode are automatically saved when you exit the Menu Mode and are retained, even when you turn the printer off.

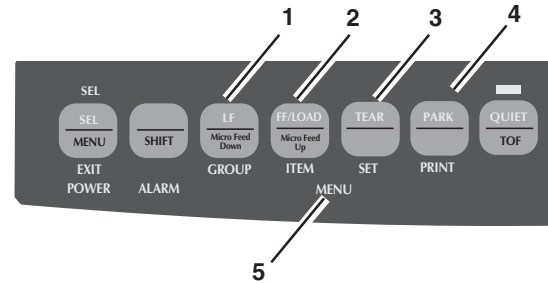

- 1 GROUP:** Prints the next Group in the Menu. With the SHIFT key, prints the previous Group.
- 2 ITEM:** Prints next Item in the Group. With the SHIFT key, prints previous Item in the Group.
- 3 SET:** Prints next Setting for an Item. With the SHIFT key, prints previous Setting for an Item.
- 4 PRINT:** Prints a copy of all the Menu settings. With the SHIFT key, prints the current settings for the Group selected.
- 5 MENU light:** Glows when the printer is in the Menu Mode.

## Entering and Exiting Menu Mode

To enter or exit the Menu Mode, hold SHIFT while pressing SEL.

## Moving Through the Menu

When the printer is in Menu Mode, you can move forward or backwards through the menu.

### Moving Forward

To move forward, press GROUP, ITEM, or SET, whichever is appropriate.

For more information, refer to “Using Your Printer, Menu Mode.”

### Moving Backward

To move backward, press and hold SHIFT, then GROUP, ITEM, or SET, whichever is appropriate.

For more information, refer to “Using Your Printer, Menu Mode.”

## Resetting Menu to Factory Defaults

- ! ***ALWAYS print the current Menu Mode settings before you reset or change the Menu settings.***
  - ***Printing the settings is the only way to have a record of the settings.***
- To print the Menu Mode Settings, refer to “Using Your Printer, Menu Mode, Printing the Menu Settings.”***

To reset the Menu to the standard settings (factory defaults):

- 1 Turn the printer off.
- 2 Press SEL + LF while turning the printer on.

## Printing the Menu Settings

- ! ***ALWAYS print the current Menu Mode settings before you reset or change the Menu settings.***
- ***Printing the settings is the only way to have a record of the settings.***

- 1 Make sure paper is loaded in the printer.
- 2 Enter the Menu Mode (SHIFT + SEL).
- 3 Press PRINT (PARK key).

- ! ***To print out a listing of the settings for all menu items, regardless of the emulation selected or the accessories installed, enter the Menu Mode, then press SHIFT + PRINT QUALITY.***

## Changing the Menu Settings

- ! ***ALWAYS print the current Menu Mode settings before you reset or change the Menu settings.***
- ***Printing the settings is the only way to have a record of the settings.***

***To print the Menu Mode Settings, refer to “Using Your Printer, Menu Mode, Printing the Menu Settings.”***

- 1 Press SHIFT + SEL to enter the Menu Mode.
- 2 Use the GROUP, ITEM and SET keys to make your changes:  
Press GROUP until the Group you wish to change appears in the first column.  
Press ITEM until the Item you wish to change appears in the second column.  
Press SET until the setting you want appears in the third column.
- 3 Press SHIFT + SEL to exit the Menu Mode and save your settings.

- ! ***Important!***
- ***If you turn off the printer without first exiting the Menu Mode, the changes you have made will be lost.***



## Menu Settings Table

For a complete explanation of each menu item, refer to “Using Your Printer, Menu Mode, Explanations of Menu Items.”

The table below shows the items which may appear in the menu. Settings which are engaged at the factory (defaults) are set in ***bold italic***. Some groups or entries will only appear when a specific emulation is engaged, as noted.

Group	Item	Settings (Defaults are set in <b><i>bold italic</i></b> )
Printer Control	Emulation Mode	<b><i>IBM PPR</i></b> , EPSON FX, ML
Font	Print Mode	<b><i>Utility</i></b> , NLQ Courier, NLQ Gothic, Draft
	Draft Mode	<b><i>HSD</i></b> , SSD
	Pitch	<b><i>10 cpi</i></b> , 12 cpi, 15 cpi, 17.1 cpi, 20 cpi
	Proportional Spacing	<b><i>No</i></b> , Yes
	Style	<b><i>Normal</i></b> , Italics
	Size	<b><i>Single</i></b> , Double
Symbol Sets	Character Set	<b><i>Standard*</i></b> , <b><i>Set I+**</i></b> , <b><i>Set II+**</i></b> , Line Graphics, Block Graphics
	Language Set	<b><i>American</i></b> , French, German, British, Danish I, Swedish, Italian, Spanish I, Japanese, Norwegian, Danish II, Spanish II, Latin American, French Canadian, Dutch, Publisher
	Zero Character	<b><i>Slashed</i></b> , Unslashed
	Code Page	<b><i>USA</i></b> , Canada French, Multilingual, Portugal, Norway, BRASC II, Abicomp, Multilingual 858, ISO 8859-15

\* Appears only when the MICROLINE Standard emulation is selected.

+\*\* Appears only when the IBM or Epson emulation is selected.

## Menu Settings Table (Continued)

For a complete explanation of each menu item, refer to “Using Your Printer, Menu Mode, Explanations of Menu Items.”

The table below shows the items which may appear in the menu. Settings which are engaged at the factory (defaults) are set in ***bold italic***. Some groups or entries will only appear when a specific emulation is engaged, as noted.

<b>Group</b>	<b>Item</b>	<b>Settings</b> (Defaults are set in <b><i>bold italic</i></b> )
Rear Feed	Line Spacing	<b><i>6 LPI</i></b> , 8 LPI
	Form Tear-Off	<b><i>Off</i></b> , 500 ms, 1 sec, 2 sec
	Skip Over Perforation	<b><i>No</i></b> , Yes
	Page Width (wide model only)	<b><i>13.6"</i></b> , 8"
	Page Length	<b><i>11"</i></b> , 11 2/3", 12", 14", 17", 3", 3.5", 4", 5.5", 6", 7", 8", 8.5"
Bottom Feed	Line Spacing	<b><i>6 LPI</i></b> , 8 LPI
	Form Tear-Off	<b><i>Off</i></b> , 500 ms, 1 sec, 2 sec
	Skip Over Perforation	<b><i>No</i></b> , Yes
	Page Width (wide model only)	<b><i>13.6"</i></b> , 8"
	Page Length	<b><i>11"</i></b> , 11-2/3", 12", 14", 17", 3", 3.5", 4", 5.5", 6", 7", 8", 8.5"

## Menu Settings Table (Continued)

For a complete explanation of each menu item, refer to “Using Your Printer, Menu Mode, Explanations of Menu Items.”

The table below shows the items which may appear in the menu. Settings which are engaged at the factory (defaults) are set in **bold italic**. Some groups or entries will only appear when a specific emulation is engaged, as noted.

Group	Item	Settings (Defaults are set in <b>bold italic</b> )
Top Feed	Line Spacing Bottom Margin Page Width (wide model only) Page Length Wait Time Page Length Control	<b>6 LPI</b> , 8 LPI <b>Valid</b> , Invalid <b>13.6"</b> , 8" <b>11"</b> , 11-2/3", 12", 14", 17", 3", 3.5", 4", 5.5", 6", 7", 8", 8.5" 500 ms, <b>1 sec</b> , 2 sec By MENU Setting, <b>By Actual Page Length</b>
Set-Up	Graphics 7 or 8 Bit Graphics* Receive Buffer Size Paper Out Override Print Registration	Bi-directional, <b>Uni-directional</b> <b>8</b> , 7 <b>64K</b> , 88 K, 1 Line, 32 K <b>No</b> , Yes <b>0</b> , set in 0.05 mm increments: press SEL to shift registration to the left; press SHIFT + SEL to shift registration to the right.

\* Appears only when the MICROLINE Standard emulation is selected.

## Menu Settings Table (Continued)

For a complete explanation of each menu item, refer to “Using Your Printer, Menu Mode, Explanations of Menu Items.”

The table below shows the items which may appear in the menu. Settings which are engaged at the factory (defaults) are set in ***bold italic***. Some groups or entries will only appear when a specific emulation is engaged, as noted.

Group	Item	Settings (Defaults are set in <b><i>bold italic</i></b> )
Set-Up (continued)	7 or 8 Bits Data Word*	<b><i>8, 7</i></b>
	Operator Panel Function	<b><i>Full Operation</i></b> , Limited Operation
	Reset Inhibit	<b><i>No</i></b> , Yes
	Print Suppress Effective	<b><i>Yes</i></b> , No
	Auto LF	<b><i>No</i></b> , Yes
	Auto CR+	<b><i>No</i></b> , Yes
	Print DEL Code*	<b><i>No</i></b> , Yes
	SI Select Pitch (10 cpi)+	<b><i>17.1 cpi</i></b> , 15 cpi
	SI Select Pitch (12 cpi)+	20 cpi, <b><i>12 cpi</i></b>
	Time Out Print	<b><i>Valid</i></b> , Invalid
	Auto Select	<b><i>No</i></b> , Yes
	Centering Position	<b><i>DEFAULT</i></b> , MODE 1, MODE 2
Power Save Time	<b><i>5 min</i></b> , 10 min, 15 min, 30 min, 60 min	

\* Appears only when the MICROLINE Standard emulation is selected.

+ Appears only when the IBM emulation is selected.

## Menu Settings Table (Continued)

For a complete explanation of each menu item, refer to “Using Your Printer, Menu Mode, Explanations of Menu Items.”

The table below shows the items which may appear in the menu. Settings which are engaged at the factory (defaults) are set in ***bold italic***. Some groups or entries will only appear when a specific emulation is engaged, as noted.

<b>Group</b>	<b>Item</b>	<b>Settings</b> (Defaults are set in <b><i>bold italic</i></b> )
Parallel I/F	I-Prime	<b><i>Buffer Print</i></b> , Invalid, Buffer Clear
	Auto Feed XT**	<b><i>Invalid</i></b> , Valid
	Bi-Direction	<b><i>Enable</i></b> , Disable

\*\* Applies only when the Epson emulation is selected.

## Explanations of Menu Items

Refer to “Using Your Printer, Menu Mode, Menu Settings Table” for an overview of the menu structure.

**7 or 8 Bits Data Word (ML).** If your computer system uses seven bits to make up each unit of data, change this setting to 7.

**7 or 8 Bit Graphics (ML).** Choose the graphics your system uses: 7 or 8 dots in each column printed.

**Auto CR (IBM).** If you want the printer to automatically add a carriage return when a Line Feed is received at the end of a line, change the setting to Yes.

**Auto LF.** If your printout is consistently double spaced, select No; if it overprints, select Yes.

**Auto Feed XT (Epson).** If your system uses pin 14 of the parallel interface to control automatic line feed, change the setting to Valid.

**Auto Select.** If you always use the same Top of Form position, change the setting to Yes.

**Bi-Direction.** Leave this set to Enable to allow the printer to communicate with the network.

**Bottom Margin.** Change to Invalid if you want the printer to ignore the bottom margin setting. Caution!! This can cause loss of data and damage the printhead.

**Centering Position.** Used to limit printhead travel when printing narrow columns.

Select Mode 1 for the narrow carriage printer.

Select Mode 1 or Mode 2 for the wide carriage printer.

**Character Set.** IBM or Epson: Choose Set I or Set II.  
Microline: Choose Standard, Line Graphics, or Block Graphics.

**Code Page.** Choose the Code Page character set you wish to use: USA (IBM 437), Canada French (IBM 863), Multilingual (IBM 850), Portugal (IBM 860), Norway (IBM 865), BRASC II, Abicomp, Multilingual 858, or ISO 8859-15.

**Draft Mode.** Change to SSD if you wish to use the Super Speed Draft mode of printing. Note: Print Mode must be set to DRAFT for this setting to be effective.

**Emulation Mode.** Choose the printer emulation.

## Explanations of Menu Items (Continued)

Refer to “Using Your Printer, Menu Mode, Menu Settings Table” for an overview of the menu structure.

**Form Tear-Off.** Choose 500 ms, 1 sec, or 2 sec to turn the Form Tear-Off feature on and to set the time interval for the printer to wait before advancing the paper.

**Graphics.** Change to bi-directional graphics for faster printing. Optimize the registration using the Print Registration setting in the Menu.

**I-Prime.** Determines what the printer will do when it receives the I-Prime signal from the software.

Buffer Print prints out the buffer contents before resetting.

Buffer Clear dumps the buffer contents immediately.

Invalid causes the printer to ignore the I-Prime command.

**Language Set.** Replaces certain standard symbols with special characters used in foreign languages.

**Line Spacing.** Change to 8 lines per inch to get more lines on a page.

**Operator Panel Function.** Change to Limited Operation to deactivate the PRINT QUALITY and CHARACTER PITCH buttons. This prevents these from being changed from the control panel when several people are using the printer.

**Page Length.** Selects the length of the paper you are using.

**Page Width (Wide Carriage only).** Change to 8" to print on letter-size paper.

**Paper Out Override.** Senses when less than 1" (25 mm) of paper remains and stops printing. Change to Yes to override the sensor. Caution!! This can cause loss of data and damage the printhead!

**Pitch.** Choose the character width, in character per inch (cpi).

**Print DEL Code (ML).** Change to Yes if you wish to print the DEL code (decimal 127) as a solid box.

**Print Mode.** Choose the quality and speed of printing.

**Print Registration.** Change the setting as required to obtain the best registration for bi-directional printing.

**Power Save Time.** Sets the interval the printer waits for more data before it goes into the power save mode.

## Explanations of Menu Items (Continued)

Refer to “Using Your Printer, Menu Mode, Menu Settings Table” for an overview of the menu structure.

**Print Suppress Effective.** If your system uses the DC1 and DC3 codes for something other than the print suppress mode, change the setting to No.

**Proportional Spacing.** Change the setting to Yes to engage proportional spacing of characters.

**Receive Buffer Size.** Selects the amount of memory devoted to holding received data. Choosing 1 Line will tie up your computer while printing, but if you abort the print job, the printer will stop much sooner.

**Reset Inhibit.** Select Yes to prevent your software from resetting your printer's settings.

**SI Select Pitch, 10 cpi (IBM).** Sets the pitch to be engaged when the printer control panel is set for 10 cpi and the SI command is received.

**SI Select Pitch, 12 cpi (IBM).** Sets the pitch to be engaged when the printer control panel is set for 12 cpi and the SI command is received.

**Size.** Change to Double for double width and height printing.

**Skip Over Perforation.** Change to Yes if you want the printer to go to the next page when it comes within 1" (25 mm) of the bottom of the page. Keep it set to No if your software has its own page formatting controls.

**Style.** Change to italics if you want the printed characters to be slanted.

**Time Out Print.** If your software spends a long time processing between portions of data it feeds to the printer, change the setting to Invalid to keep your printer from dumping the received data while it is waiting for more.

**Wait Time.** Sets the amount of time the printer will wait for more data before moving to the form tear-off position.

**Zero Character.** If you do not want the printer to use a slash to distinguish the number zero from the capital letter O, change the setting to Unslashed.



# Maintenance

## Replacing the Ribbon Cartridge

If you need instructions for replacing the ribbon cartridge, you can refer to the

- packaging of the new cartridge
- web site
- “Installation, Ribbon Cartridge.”

For the best results, use genuine OKI ribbons.

For information on obtaining consumables, refer to “Accessories.”

For information on the web site, refer to “Service and Support, Internet Support.”

## Printer Cleaning

You should clean the printer every six months (or after about 300 hours of operation).

! *Never use solvents or strong detergents on the cabinet: they could cause damage.*

- 1 Turn off the printer. Then, use the platen knob to back the paper out of the printer.
- 2 Open the access cover. Remove the pull-up roller assembly.

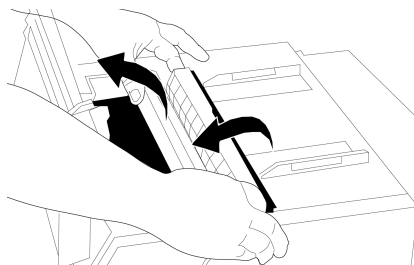

- 3 Use a clean, dry cloth to dust around the carriage shaft and platen. Remove any loose bits of paper.
- 4 Install the pull-up roller assembly. Close the access cover.

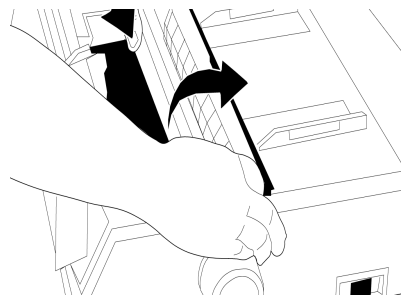

# Paper Jams

## Rear-Feed Paper Jams

- 1 Turn off the printer. Then, use the platen knob to back the paper out of the printer.

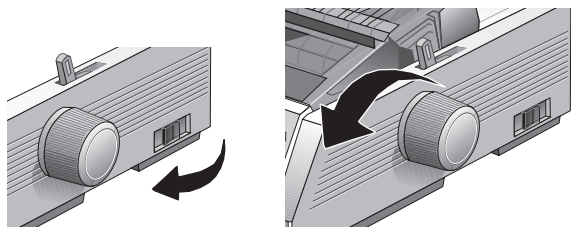

- ! *Make sure the printer is turned off before you open the access cover.*

- 2 Open the access cover. Remove the pull-up roller assembly.

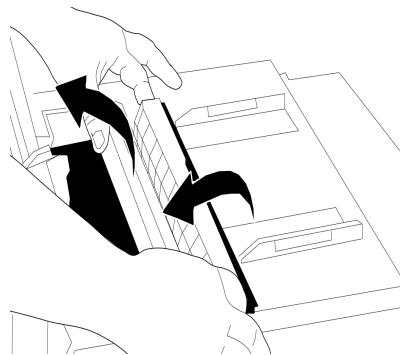

- 3 Remove any torn pieces of paper.
- 4 Grasp the tabs and lift off the paper separator. Load paper.

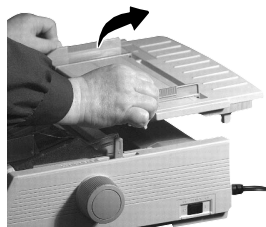

- 5 Install the paper separator. Install the pull-up roller assembly. Close the access cover.

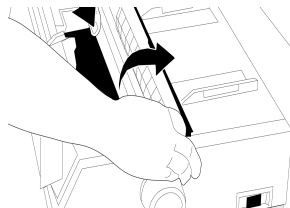
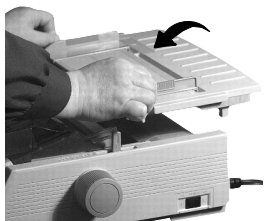

- 6 Turn on the printer.

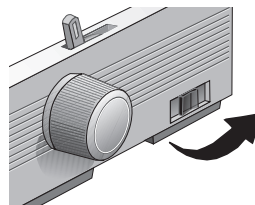

- 7 Press FF/LOAD.



## Rear-Feed, Repeating Paper Jams

If the paper keeps jamming, you probably have bits of paper stuck in the paper path.

- 1 Turn off the printer. Then, use the platen knob to back the paper out of the printer.
- 2 Open the access cover. Remove the pull up roller assembly. Remove any torn pieces of paper.

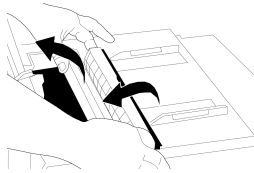

- 3 Grasp the tabs and lift off the paper separator.

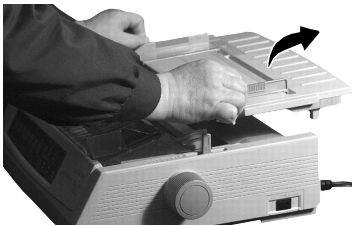

- 4 Fold some continuous-form paper over three times to make a page four sheets thick. Then, load it on the tractors and close the covers.

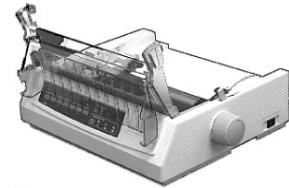

- 5 Use the platen knob to draw the quadruple-thick page around the platen. This clears any jammed bits of paper.

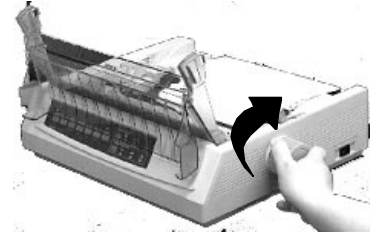

**6** Remove any paper pieces. Then, use the platen knob to back the paper out.

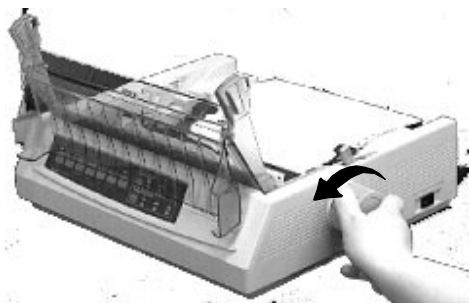

**7** Load regular paper. Install the paper separator.



**8** Install the pull-up roller assembly. Close the access cover.

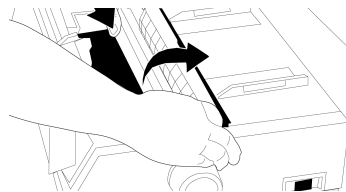

**9** Turn on the printer.

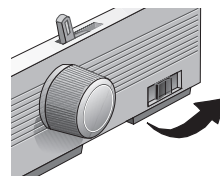

**10** Press FF/LOAD.



## Single-Sheet Paper Jams

- 1 Turn off the printer.
- 2 Then, use the platen knob to back the paper out.

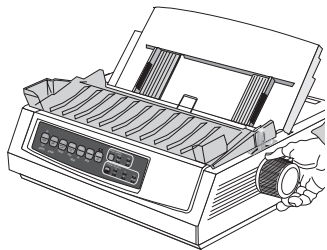

- 3 Open the access cover. Remove the pull-up roller assembly.

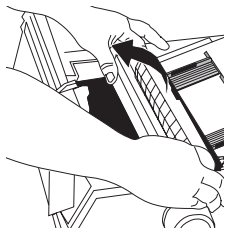

- 4 Remove any torn pieces from around the carriage.
- 5 Install the pull-up roller assembly. Close the access cover.

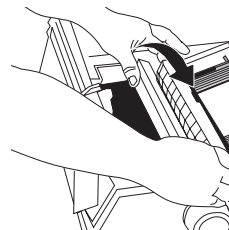

- 6 Turn on the printer. Load paper.

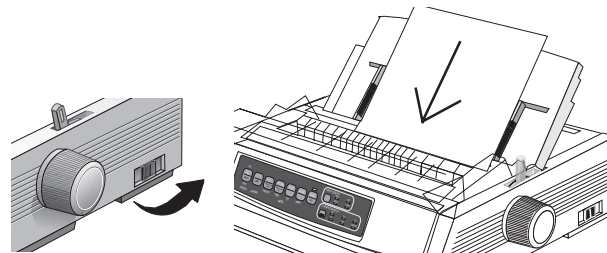

# Troubleshooting

## General Information

Here are some general things to check before proceeding with detailed troubleshooting.

- Is the printer plugged in and turned on?
- Are the connections (power and interface) secure?
- Is the product being operated under the proper ambient conditions?
- Does the paper being used meet the specifications for this product?
- Is the paper properly installed?
- Has the ribbon been replaced as recommended?
- Is the ribbon properly installed?
- Is an OKI ribbon being used?
- Is the printhead gap correctly set?
- Are the correct printer drivers being used for the printer?

- ! *Settings in your software application will override any settings in your printer driver.*
- *Your printer driver settings will override any settings from the printer menu or printer front panel.*

## Internet Support

Oki Data provides support via the Internet.

Oki Data's main web site, [www.okidata.com](http://www.okidata.com), is the gateway to Oki Data's products and services.

[my.okidata.com](http://my.okidata.com) is a powerful area of Oki Data's web site designed to help you personalize the information and service you get from Oki Data.

For more information, refer to "Service and Support, Internet Support."



## List of Problems

### **Problem 1:**

My word processor files do not print the way I have the menu and front panel set.

### **Problem 2:**

Nothing happens when I turn on the printer.

### **Problem 3:**

The printer does not print when the computer sends data.

### **Problem 4:**

I'm getting strange symbols, incorrect fonts, etc., when I try to print a document.

### **Problem 5:**

Ink smears on the paper when I print on narrow forms.

### **Problem 6:**

I've installed a new ribbon and the printing is smeared and streaked.

### **Problem 7:**

The ALARM light is flashing.

### **Problem 8:**

The ALARM light is on and the Character Pitch 10 light is flashing.

### **Problem 9:**

The ALARM light is on and the Character Pitch 15 light is flashing.

### **Problem 10:**

The printer needs paper, but the ALARM light is not on and I cannot load the paper.

### **Problem 11:**

The Print Quality and Character Pitch keys on the front panel don't work.

### **Problem 12:**

Continuous-form paper sticks to the paper separator.

### **Problem 13:**

Nothing happens when I print to the parallel port.

**Problem 1:**

*My word processor files do not print the way I have the menu and front panel set.*

**Solution:**

Always remember that:

- 1 Settings in your software application will override any settings in your printer driver.
- 2 Your printer driver settings will override any settings from the printer menu or printer front panel.

**Solution:**

Before sending a file to the printer, many word processors send either an “initialization string” or an I-Prime signal to the printer.

The initialization string contains codes that override the panel and menu settings. To change your printer to ignore the reset code, enter the Menu Mode, go to the Set-Up group and change the setting for Reset Inhibit to Yes. Refer to “Using Your Printer, Menu Mode.”

The I-Prime signal will automatically override any front panel settings you have made. To eliminate this problem, enter the Menu Mode, go to the Parallel Interface group and change the setting for I Prime to Invalid. Refer to “Using Your Printer, Menu Mode.”

**Problem 2:**

*Nothing happens when I turn on the printer.*

**Solution:**

Check the power cord connection to the outlet. If you are using a power strip, make sure it is turned on, and that a fuse hasn't blown or that a circuit breaker hasn't tripped.

**Problem 3:**

*The printer does not print when the computer sends data.*

**Solutions:**

- 1 Is the SEL light on? If not, press the SEL key.
- 2 Check that all interface cables are securely connected to the printer and the computer.

**Problem 4:**

*I'm getting strange symbols, incorrect fonts, etc., when I try to print a document.*

**Solutions:**

- 1 Check to be sure that the printer driver you have selected in your software matches the printer emulation.  
Press SHIFT and SEL keys, then press GROUP key.  
This will print a line showing the emulation you have selected.
- 2 If you have embedded any printer commands in your software, check to be sure that you entered them correctly.

**Problem 5:**

*Ink smears on the paper when I print on narrow forms.*

**Solution:**

This may be caused by excessive printhead travel from the centering position. Enter the Menu and set the Centering Position to MODE 1. Refer to “Using Your Printer, Menu Mode.”

For the wide-carriage printer, if MODE 1 doesn't work, try setting the Centering Position to MODE 2.

**Problem 6:**

*I've installed a new ribbon and the printing is smeared and streaked.*

**Solution:**

The ribbon shield is either loose or missing. Remove the ribbon cartridge and check the ribbon shield.

If it is loose, secure it.

If it is missing, find it and install it.

**Problem 7:**

*The ALARM light is flashing.*

**Solution:**

Try turning the printer off and then back on again. If the light still blinks, call for service.

**Problem 8:**

*The ALARM light is on and the Character Pitch 10 light is flashing.*

**Solution:**

This indicates that the paper lever is set at the wrong position for the paper you are trying to use. Move it to the proper setting.

**Problem 9:**

*The ALARM light is on and the Character Pitch 15 light is flashing.*

**Solution:**

This indicates a paper jam. Press the SEL key and correct the paper jam situation. Refer to “Maintenance, Paper Jams.”

**Problem 10:**

*The printer needs paper, but the ALARM light is not on and I cannot load the paper.*

**Solution:**

Press and release the SEL key.

Then, press and hold the SHIFT key and press the RESET (CHARACTER PITCH) key.

The printer is reset.

**Problem 11:**

*The Print Quality and Character Pitch keys on the front panel don't work.*

**Solution:**

The Operator Panel Function in the printer menu can be used to disable these buttons (Limited Function). If the printer is part of a customized system or if it is used by a number of people, the system manager may have used this option to make sure the printer is always set properly.

Check with your system manager before changing any menu settings.

Refer to “Using Your Printer, Menu Mode.”

**Problem 12:**

*Continuous-form paper sticks to the paper separator.*

**Solution:**

In cold dry weather, static charges can build up and make the paper cling to the paper separator. Try moving the paper guides together so that the paper rests on the guides rather than on the separator.

**Problem 13:**

*Nothing happens when I print to the parallel port.*

**Solution:**

Remove the Network Card from the printer.

- ! *If you want to use the parallel port, you **MUST** remove the Network Card from the printer. See the OkiLAN 6120e User's Guide for details.*

# Specifications

! *Specifications subject to change without notice.*

- *Network specifications are in the OkiLAN 6120e User's Guide.*

## Print Method

Impact dot matrix

## Printhead

9 pins, 0.34 mm diameter, thermal protection

## Print Speed

### *Mode Characters per second*

Super Speed Draft (SSD)	435 cps
High Speed Draft (HSD)	390 cps
Utility (UTL)	300 cps
Near Letter Quality (NLQ)	75 cps

## Characters per Line (cpl)

<i>Setting</i>	<i>ML320 Turbo/n</i>	<i>ML321 Turbo/n</i>
10 cpi	80 cpl	136 cpl
12 cpi	96 cpl	163 cpl
15 cpi	120 cpl	204 cpl
17.1 cpi	137 cpl	233 cpl
20 cpi	160 cpl	272 cpl

## Emulations

Epson FX (ESC/P)

IBM Proprinter III(PPSII)

Oki Data Microline Standard co-resident

## Interface

Standard:

Ethernet

Centronics parallel, IEEE-1284 compliant

- ! *If you want to use the parallel port, you **MUST** remove the Network Card from the printer. See the OkiLAN 6120e User's Guide for details.*
- 

## Graphics Resolution

<i>Emulation</i>	<i>Maximum Resolution</i>
Epson/IBM	240 (H) x 216 (V) dpi
OKIDATA	288 (H) x 144 (V) dpi

## Resident Fonts

<i>Print Quality</i>	<i>Available Fonts</i>
Near Letter Quality	Courier, Gothic
Utility	Gothic
High Speed Draft	Gothic
Super Speed Draft	Gothic

## Resident Scalable Fonts\*

Courier and Gothic, in sizes from 22 to 216 points

\*Selectable through software only.

## Bar Codes

Code 39, UPC A, UPC E, EAN 8, EAN 13,

Interleaved 2 of 5, Code 128, Postnet

## Receive Buffer Size

1 Line, 16 K, 28K, 64K

## Reliability

### Mean Time Between Failures (MTBF)

10,000 hours at 25% duty cycle and 35% page density

### Mean Time to Repair (MTTR)

15 minutes

### Printhead Life

200 million characters average in 10 cpi draft mode at 25% duty and 35% page density

### Ribbon Life

3 million characters, on average, 10 cpi utility



## Paper Specifications

### Narrow Carriage: Microline 320 Turbo/n

<b>Paper Type:</b>	Cut Sheet
<b>Feed:</b>	Top
<b>Weight:</b>	14-24 lb. (52.5-90 g/m <sup>2</sup> )
<b>Width Range:</b>	7.2" to 8.5" (182.8 to 215.9 mm)
<b>Paper Type:</b>	Single-part, continuous forms
<b>Feed:</b>	Rear, Bottom
<b>Weight:</b>	12-24 lb. (45-90 g/m <sup>2</sup> )
<b>Width Range:</b>	3" to 10" (76.2 to 254 mm)
<b>Paper Type:</b>	Carbonless continuous forms
<b>Feed:</b>	Rear, Bottom
<b>Weight:</b>	9-11 lb. (33.75-41.25 g/m <sup>2</sup> )
<b>Width Range:</b>	3-10" (76.2 to 254 mm)
<b>Paper Type:</b>	Interleaf continuous forms
<b>Feed:</b>	Rear, Bottom
<b>Weight:</b>	Not applicable
<b>Width Range:</b>	3-10" (76.2 to 254 mm)
<b>Paper Type:</b>	Labels
<b>Feed:</b>	Bottom
<b>Weight:</b>	Not applicable
<b>Width Range:</b>	3-10" (76.2 to 254 mm)

<b>Paper Type:</b>	Envelopes, single feed
<b>Feed:</b>	Top
<b>Weight:</b>	24 lb. max. (90 g/m <sup>2</sup> )
<b>Width Range:</b>	6.5" to 9.5" (165.1 to 241.3 mm)
<b>Paper Type:</b>	Envelopes, continuous feed, non-overlap
<b>Feed:</b>	Bottom
<b>Weight:</b>	24 lb. max. (90 g/m <sup>2</sup> )
<b>Width Range:</b>	6.5" to 9.5" (165.1 to 241.3 mm)
<b>Paper Type:</b>	Card stock
<b>Feed:</b>	Bottom
<b>Weight:</b>	120 lb. max. (450 g/m <sup>2</sup> )
<b>Width Range:</b>	Not applicable
<b>Paper Type:</b>	Transparencies
<b>Feed:</b>	Top
<b>Weight:</b>	Not applicable
<b>Width Range:</b>	Not applicable
	Standard Transparencies are 8.5" x 11" (215.9 - 279.4 mm)

## Paper Specifications

### Wide Carriage: Microline 321 Turbo/n

<b>Paper Type:</b>	Cut Sheet
<b>Feed:</b>	Top
<b>Weight:</b>	14-24 lb. (52.5-90 g/m <sup>2</sup> )
<b>Width Range:</b>	7.2" to 14.3" (182.8 to 363.2 mm)
<b>Paper Type:</b>	Single-part, continuous forms
<b>Feed:</b>	Rear, Bottom
<b>Weight:</b>	12-24 lb. (45-90 g/m <sup>2</sup> )
<b>Width Range:</b>	3" to 16" (76.2 to 406.4 mm)
<b>Paper Type:</b>	Carbonless continuous forms
<b>Feed:</b>	Rear, Bottom
<b>Weight:</b>	9-11 lb. (33.75-41.25 g/m <sup>2</sup> )
<b>Width Range:</b>	3" to 16" (76.2 to 406.4 mm)
<b>Paper Type:</b>	Interleaf continuous forms
<b>Feed:</b>	Rear, Bottom
<b>Weight:</b>	Not applicable
<b>Width Range:</b>	3" to 16" (76.2 to 406.4 mm)
<b>Paper Type:</b>	Labels
<b>Feed:</b>	Bottom
<b>Weight:</b>	Not applicable
<b>Width Range:</b>	3" to 16" (76.2 to 406.4 mm)

<b>Paper Type:</b>	Envelopes, single feed
<b>Feed:</b>	Top
<b>Weight:</b>	24 lb. max. (90 g/m <sup>2</sup> )
<b>Width Range:</b>	6.5" to 9.5" (165.1 to 241.3 mm)
<b>Paper Type:</b>	Envelopes, continuous feed, non-overlap
<b>Feed:</b>	Bottom
<b>Weight:</b>	24 lb. max. (90 g/m <sup>2</sup> )
<b>Width Range:</b>	6.5" to 9.5" (165.1 to 241.3 mm)
<b>Paper Type:</b>	Card stock
<b>Feed:</b>	Bottom
<b>Weight:</b>	120 lb. max. (450 g/m <sup>2</sup> )
<b>Width Range:</b>	Not applicable
<b>Paper Type:</b>	Transparencies
<b>Feed:</b>	Top
<b>Weight:</b>	Not applicable
<b>Width Range:</b>	Not applicable
	Standard Transparencies are 8.5" x 11" (215.9 - 279.4 mm)

## Paper Thickness

### Rear Feed

0.014" (0.36 mm) maximum

### Bottom Feed\*

0.017" (0.43 mm) maximum  
expandable to 0.031" (0.79 mm) maximum

\* Requires optional push or pull tractor.

## Printer Dimensions

### Width x Depth x Height

#### Narrow Carriage

ML 320 Turbo/n

15.7 x 13.6 x 4.6 inches  
389 x 355 x 116 mm

#### Wide Carriage

ML321 Turbo/n

21.7 x 13.6 x 4.6 inches  
550 x 355 x 116 mm

## Printer Weight

### Narrow Carriage

ML 320 Turbo/n

17.2 lbs. (7.8 kg)

### Wide Carriage

ML321 Turbo/n

22.2 lbs. (10.1 kg)

## Environmental Requirements

### Temperature

Operating 41 to 104°F (5 to 40°C)

Storage 14 to 122°F (-10 to 50°C)

### Humidity

Operating 20 to 80% RH

Storage 5 to 95% RH

## Electrical Requirements

120 volts ac (+5.5%, -15%), 60 Hz (±2%)

Also available: 230 or 240 volts ac, 50 or 60 Hz (±2%)



*Specifications subject to change without notice.*

# Service and Support

## General Information

Oki Data offers service and support to you through a variety of methods.

Please choose the service and support method that is best for you.

Oki Data's service and support methods are:

- the documentation provided with your machine
- the store location where you purchased your machine
- Internet Support
- Telephone Support

Details of each support method are provided in this section.

Oki Data's service and support methods are different in these two areas:

- United States and Canada
- Latin America

Details for each area are provided in this section.

Service Centers are trained by Oki Data and are authorized to service OKI products. For more information about Service Centers, refer to "Service and Support, Service Centers."

## Documentation

The documentation provided with your machine provides an excellent reference for the day-to-day operation of your machine.

The documentation included with your machine is:

- Printer User's Guide, on line, provided on the CD
- OkiLAN 6120e User's Guide, on line, provided on the CD
- Microline Reference Manual, on line, provided on the CD
- Quick Start
- Warranty, Regulatory, and Safety Information

If you cannot locate your documentation, go to [www.okidata.com](http://www.okidata.com) or [my.okidata.com](http://my.okidata.com). Follow the prompts for your product, and you will find the on-line versions of all of these documents.

## Purchase Location

The store location where you purchased your machine provides an excellent, local means of support for you and your machine.

Your purchase location will also provide any warranty service required by your machine

- ! ***You will need your printer serial number if your machine requires servicing.***  
***A written receipt for the product, showing the date of purchase, dealer's name, and both the model and serial numbers of the product must accompany any request or claim for work to be performed under Limited Warranty.***

# Internet Support

## **www.okidata.com**

### **Your Gateway to OKI Products and Services**

www.okidata.com is Oki Data's web site. It provides general information about all of the OKI products and services available to you.

You can use our web site to

- get Web-based support for all OKI products: 24 hours a day, 7 days a week—no waiting!
- download the printer drivers you need.
- read about other customers and how they use OKI products to improve their productivity and enhance their documentation.
- use the Dealer Locator to find a dealer location close to you.
- find out about Oki Data's special promotional offers and breaking news.
- and more . . .

## **my.okidata.com**

### **Your Personal Solutions Center**

my.okidata.com is a powerful area of Oki Data's web site designed to help you personalize the information and service you get from Oki Data.

When you register for my.okidata.com, you

- personalize the web-based support for the OKI products you own: 24 hours a day, 7 days a week—no waiting!
- automatically register your product.
- access on-line versions of your product documentation (manuals) and support information.
- control your contact, profile, and preference information.
- receive automatic notification of new printer drivers, key updates, and support information.
- track your e-mail support history.
- and more . . .

# Telephone Support

## Okidata Customer Information System

### Automated Attendant

1-800-654-3282 (1-800-OKI-DATA)

Toll Free in the U.S. and Canada

For quick answers to commonly-asked questions, the Automated Attendant is available 24 hours a day, 7 days a week. The system can provide immediate assistance with:

- Basic operating procedures
- Sales and service referrals
- Parts and consumable referrals
- Product information

### Customer Support Professionals

1-800-654-3282 (1-800-OKI-DATA)

Toll Free in the U.S. and Canada

Customer Support Professionals are available 24 hours a day, 7 days a week. Please be sure that you are calling from a telephone close to your machine so you can describe your problem accurately.

Our Customer Support Professionals are trained on all current OKI products. They can answer your questions regarding:

- Locations of sales and service dealers
- Installation of your machine
- Usage/normal maintenance of your machine
- Error message interpretation/solutions
- Parts and supplies identification
- Consumer relations

## Service Centers

### Authorized Service Providers

Oki Data has over 2,000 local Authorized Service Providers in North and South America.

For the most comprehensive, up-to-date listing of Oki Data authorized Service Centers:

- Consult our web site at **www.okidata.com**
- In the U.S. and Canada, call 1-800-654-3282 (1-800-OKI-DATA)
- In Latin America, contact the Latin America Service Coordinator at Oki Data's Corporate Headquarters at 856-222-7496 (Spanish only)

### Oki Data Contact Locations

#### United States

Oki Data Americas, Inc.  
2020 Bishops Gate Blvd.  
Mt. Laurel, NJ 08054  
Phone: 1-800-654-3282  
Fax: 1-856-222-5247

#### Canada

Oki Data Americas, Inc.  
2735 Matheson Blvd. East, Unit 1  
Mississauga, Ontario  
Canada L4W 4M8  
Phone: 1-800-654-3282  
Fax: 1-905-238-4421

#### Mexico

Oki Data de Mexico, S.A. de C.V.  
Mariano Escobedo No. 748-8 Piso  
Col. Anzures, e.p. 11590  
Mexico, DF  
Phone: (525) 263-8780  
Fax: (525) 250-3501

#### Brazil

Oki Data do Brasil, Ltda.  
Rua Alexandre Dumas, 2220 - 8 andar  
Chácara Sto Antonio  
São Paulo, Brazil 04717-004  
Phone: 55-11-3444-3500  
Fax: 55-11-3444-3501



## **Service and Support: United States and Canada**

Oki Data is firmly committed to the satisfaction of our customers. If you have a problem that your customer documentation cannot solve, contact the listed sources for service or support.

## **Sales and Service Dealers: United States and Canada**

Consult the store location where you purchased your machine, or contact Oki Data for the location of the nearest Authorized Oki Data Service Dealer.

- Prices and minimum charges may vary.
- Proof of purchase is required for warranty work. Be sure to retain your purchase documents.

## Service and Support: Latin America

Oki Data is committed to offer the best customer support possible to our customers. In the instance of having a difficult problem with your OKI product, please contact any of the OKI- CAS (Centro Autorizado de Servicio) shown on our Web site, [www.okidata.com](http://www.okidata.com).

### Sales and Service Centers: Latin America

If you need to service your OKI product, please contact the store where you bought your fax machine or contact any of the OKI-CAS listed on our Web site for information.

- Prices and charges may vary.
- A copy of the proof of purchase is required for the warranty process.

### Contacting Oki Data: Latin America

Information regarding our products and authorized service centers is available in our Web site:

<http://www.okidata.com>

## Customer Support Professionals: Latin America

Our CAS's are trained and certified to provide the best service and support possible to our customers. Make sure that you are close to your machine when you call one of our OKI authorized service centers (OKI-CAS) so that you can describe your problem more accurately.

Our customer support professionals are trained on all current OKI products. They can answer your questions regarding:

- Location of nearest CAS (Service Center).
- Installation of your machine.
- Usage/normal maintenance of your machine.
- Error message interpretation/solutions
- Parts and supplies identification.
- Consumer relations.

# Accessories

## Purchasing Accessories

Before you purchase, know your machine model number (see the front of the unit) and have the correct part number and description of the item. Item descriptions and part numbers are provided in this section.

- Consult the dealer where you purchased your machine.
- Locate an Authorized Oki Data Reseller by visiting one of these web sites
  - <http://my.okidata.com>  
Allows you to register your product and personalize your own support needs
  - <http://www.okidata.com>  
Provides general information
- In the United States, purchase directly from Oki Data
  - Via the Internet
    - <http://my.okidata.com>
    - <http://www.okidata.com>
  - Via telephone
    - Order toll-free by phone at 1-800-654-3282 (1-800-OKI-DATA) using VISA, MasterCard, or American Express.
- In Canada, call 888-309-4570.

## Accessories: Part Numbers

### Consumables: Part Numbers

Consumable	Part Number
Ribbon Cartridge (1) -----	52102001

### Options: Part Numbers

Option	Part Number
<i>Microline 320 Turbo/n</i>	
Pull Tractor, Top-Mount (2) -----	70030501
Push Tractor, Bottom-Mount (3) -----	70030701
Roll Paper Stand (4) -----	70023301
<i>Microline 321 Turbo/n</i>	
Pull Tractor, Top-Mount (2) -----	70030601
Push Tractor, Bottom-Mount (3) -----	70030801

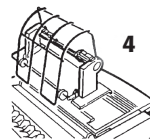
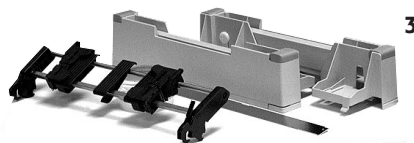
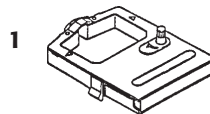

## Replacement Parts: Part Numbers

### Replacement Part ----- Order No.

#### *Both Models*

Platen Knob (1) ----- 51902220

Power Cord (2) ----- 56631801

Printhead (3) ----- 50114601

#### *Microline 320 Turbo/n*

Access Cover (4) ----- 53076701

Acoustic Cover (5) ----- 53076901

Pull-Up Roller Assembly (6) ----- 50411001

#### *Microline 320 Turbo/n*

Access Cover (4) ----- 53076801

Acoustic Cover (5) ----- 53077001

Pull-Up Roller Assembly (6) ----- 50411101



1



2



3

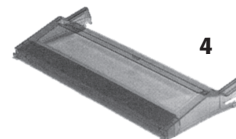

4

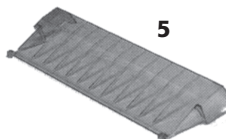

5

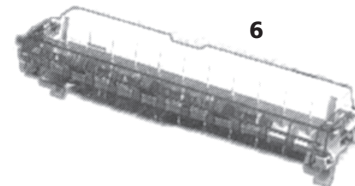

6

## Documentation

### Document

### Part Number

Quick Start----- refer to my.okidata.com  
Printer User's Guide ----- refer to my.okidata.com  
OkiLAN 6120e User's Guide ----- refer to my.okidata.com  
Microline Reference Manual ----- refer to my.okidata.com  
Warranty, Regulatory, and  
Safety Information----- refer to my.okidata.com

! • *If you cannot locate your hardcopy documentation or the CD provided with your machine, go to [www.okidata.com](http://www.okidata.com) or [my.okidata.com](http://my.okidata.com). Follow the prompts for your product, and you will find the on-line versions of all of these documents.*

# Printer Control Codes

This section lists the most commonly used printer control codes.

The Microline Reference Manual provides complete lists of all the commands, along with information on their use.

You may view this document by:

- accessing the document on the CD provided with your machine
- using the Oki Data web sites  
<http://www.okidata.com>  
or  
[my.okidata.com](http://my.okidata.com)

! *The Microline Reference Manual is ONLY available in American English.*

## Epson FX Commands

Epson Command	ASCII	Decimal
Backspace	BS	8
Carriage Return, Execute	CR	13
Character Pitch		
Select 10 cpi	ESC P	27 80
Select 12 cpi	ESC M	27 77
Select 15 cpi	ESC g	27 103
Select Condensed Print	ESC SI, or SI	27 15, or 15
Cancel Condensed Print	DC2	18
Delete	DEL	127
Double Height On	ESC w 1	27 119 49
Double Height Off	ESC w 0	27 119 48
Double Width On	ESC W 1	27 87 49
Double Width Off	ESC W 0	27 87 48
Emphasized Print On	ESC E	27 69
Emphasized Print Off	ESC F	27 70
Enhanced Print On	ESC G	27 71
Enhanced Print Off	ESC H	27 72
Epson Set 1, Select	ESC t 0	27 116 48
Epson Set 2, Select	ESC t 1	27 116 49
Italic Printing On	ESC 4	27 52
Italic Printing Off	ESC 5	27 53
Form Feed	FF	12

Epson Command	ASCII	Decimal
Form Length		
n Inches (n = 1 to 22)	ESC C NUL n	27 67 0 n
n Lines (n = 1 to 255)	ESC C n	27 67 n
Horizontal Tab	HT	9
Justification		
Left	ESC a 0	27 97 48
Center	ESC a 1	27 97 49
Right	ESC a 2	27 97 50
Full	ESC a 3	27 97 51
Line Feed, Execute		
Select 10 cpi	ESC P	27 80
Select 12 cpi	ESC M	27 77
w/ Carriage Return	LF	10
n/216" (n = 0 to 255)	ESC J n	27 74 n
n/144" (n = 0 to 127)	ESC % 5 n	27 37 53 n
Reverse, n/216" (n = 0 to 255)	ESC j n	27 106 n
Line Spacing, Set		
n/144" (n = 0 to 127)	ESC % 9 n	27 37 57 n
n/216" (n = 0 to 255)	ESC 3 n	27 51 n
n/72" (n = 0-85 or 128-213)	ESC A n	27 65 n
1/6"	ESC 2	27 50
1/8"	ESC 0	27 48
7/72"	ESC 1	27 49



## Epson FX Commands (Continued)

Epson Command	ASCII	Decimal
Paper Out Sensor Off	ESC 8	27 56
Paper Out Sensor On	ESC 9	27 57
Print Quality/Font Select HSD/SSD, depending on Menu setting for Draft Mode	ESC ( 0	27 40 48
Select NLQ	ESC x 1	27 120 49
Select Courier (NLQ only)	ESC k 0	27 107 48
Select Gothic (NLQ only)	ESC k 1	27 107 49
Select UTL	ESC x 0	27 120 48
Print Speed Half-Speed On	ESC s 1	27 115 49
Half-Speed Off	ESC s 0	27 115 48
Print Suppress Mode On	DC3	19
Print Suppress Mode Off	DC1	17
Proportional Spacing On	ESC p 1	27 112 49
Proportional Spacing Off	ESC p 0	27 112 48
Reset Printer Clear Buffer & Initialize	ESC @	27 64
Clear Print Buffer	CAN	24
Skip Over Perforation, Cancel	ESC O	27 79
Software I-Prime	ESC } NUL	27 125 0

Epson Command	ASCII	Decimal
Subscript On	ESC S 1	27 83 49
Superscript On	ESC S 0	27 83 48
Subscript/Superscript Off	ESC T	27 84
Underline On	ESC - 1	27 45 49
Underline Off	ESC - 0	27 45 48
Uni-Directional Printing One Line Only	ESC <	27 60
On	ESC U 1	27 85 49
Off	ESC U 0	27 85 48
Vertical Tab, Execute	VT	11

## IBM Proprinter III Commands

IBM Command	ASCII	Decimal
Backspace	BS	8
Carriage Return	CR	13
Character Pitch		
Select 10 cpi	DC2	18
Select 12 cpi	ESC :	27 58
Select 15 cpi	ESC g	27 103
Select Condensed Print	ESC SI, or SI	27 15, or 15
Character Sets		
IBM Set I	ESC 7	27 55
IBM Set II	ESC 6	27 54
Publisher	ESC !Z	27 33 90
Slashed Zero	ESC !@	27 33 64
Unslashed Zero	ESC !A	27 33 65
Double Width On	ESC W 1	27 87 49
Double Width Off	ESC W 0	27 87 48
Emphasized Printing On	ESC E	27 69
Emphasized Printing Off	ESC F	27 70
Enhanced Printing On	ESC G	27 71
Enhanced Printing Off	ESC H	27 72
Form Feed	FF	12

IBM Command	ASCII	Decimal
Form Length, n inches (n = 1 to 22)	ESC C NUL n	27 67 0 n
Form Length, n lines (n = 1 to 255)	ESC C n	27 67 n
Horizontal Tab, Execute	HT	9
Italics On	ESC % G	27 37 71
Italics Off	ESC % H	27 37 72
Line Feed, Execute		
w/ Carriage Return	LF	10
n/144" (n = 1 to 127)	ESC % 5 n	27 37 53 n
n/216" (n = 0 to 255)	ESC J n	27 74 n
Reverse	ESC ]	27 93
Auto Line Feed On	ESC 5 1	27 53 49
Auto Line Feed Off	ESC 5 0	27 53 48

## IBM Proprinter III Commands (Continued)

IBM Command	ASCII	Decimal
Line Spacing		
Set Spacing to 1/8"	ESC 0	27 48
Set Spacing to 7/72"	ESC 1	27 49
Set Spacing to n/72" (n = 0 to 255)	ESC A n	27 65 n
Store Spacing Set by ESC A n	ESC 2	27 50
Set Spacing to n/144" (n = 1 to 127)	ESC A n ESC A n	27 65 n 27 65 n
Set Spacing to n/216" (n = 0 to 255)	ESC A n ESC A n	27 65 n 27 65 n
Overscore On	ESC _ 1	27 95 49
Overscore Off	ESC _ 0	27 95 48
Paper Out Sensor Off	ESC 8	27 56
Paper Out Sensor On	ESC 9	27 57
Print Quality, Select HSD	ESC # 0	27 35 48
Print Suppress On, ML320T	ESC Q ETX	27 81 3
Print Suppress On, ML321T	ESC Q SYN	27 81 22
Print Suppress Off	DC1	17
Proportional Spacing On	ESC P 1	27 80 49
Proportional Spacing Off	ESC P 0	27 80 48
Reset: Clear Print Buffer	CAN	24
Software I-Prime	ESC } NUL	27 125 0

IBM Command	ASCII	Decimal
Stop Printing	ESC j	27 106
Subscript On	ESC S 1	27 83 49
Superscript On	ESC S 0	27 83 48
Subscript/Superscript Off	ESC T	27 84
Top of Form, Set at Current Position	ESC 4	27 52
Underline Printing On	ESC - 1	27 45 49
Underline Printing Off	ESC - 0	27 45 48
Uni-Directional Print On	ESC U 1	27 85 49
Uni-Directional Print Off	ESC U 0	27 85 48
Vertical Tab, Execute	VT	11

## Oki Data MICROLINE Standard Commands

Oki Data Command	ASCII	Decimal
Backspace	BS	8
Carriage Return	CR	13
Character Pitch		
Select 10 cpi	RS	30
Select 12 cpi	FS	28
Select 15 cpi	ESC g	27 103
Select 17.1 cpi	GS	29
Select 20 cpi	ESC # 3	27 35 51
Character Sets		
Standard	ESC ! 0	27 33 48
Block Graphic	ESC ! 1	27 33 49
Line Graphics	ESC ! 2	27 33 50
Publisher	ESC ! Z	27 33 90
Slashed Zero	ESC ! @	27 33 64
Unslashed Zero	ESC ! A	27 33 65
Double Height On	ESC US 1	27 31 49
Double Height Off	ESC US 0	27 31 48
Double Width Printing	US	31
Emphasized Printing On	ESC T	27 84
Emphasized Printing Off	ESC I	27 73

Oki Data Command	ASCII	Decimal
Enhanced Printing On	ESCH	27 72
Enhanced Printing Off	ESC I	27 73
Form Feed	FF	12
Horizontal Tab, Execute	HT	9
Italic On	ESC ! /	27 33 47
Italic Off	ESC ! *	27 33 42
Line Feed Commands		
w/ Carriage Return	LF	10
w/o Carriage Return	ESC DC2	27 18
n/144" (n = 0 to 127)	ESC % 5 n	27 37 53 n
Reverse	ESC LF	27 10
Line Spacing		
Set Spacing to 1/6"	ESC 6	27 54
Set Spacing to 1/8"	ESC 8	27 56
Set Spacing, in n/144"		
(n = 0 to 127)	ESC % 9 n	27 37 57 n
Skip Over Perforation, in		
1/3" increments (n = 1 to 9)	ESC G nn	27 71 nn
Skip Over Perforation		
Default	ESC % S 0	27 37 83 48

## Okidata MICROLINE Standard Commands (Continued)

Okidata Command	ASCII	Decimal
Paper Out Sensor Off	ESC E 1	27 69 49
Paper Out Sensor On	ESC E 0	27 69 48
Print Quality		
Select HSD/SSD	ESC # 0	27 35 48
Select NLQ Courier	ESC 1	27 49
Select NLQ Gothic	ESC 3	27 51
Select Utility	ESC 0	27 48
Print Speed, Set to Full	ESC >	27 62
Print Speed, Set to Half	ESC <	27 60
Print Suppress On	DC3	19
Print Suppress Off	DC1	17
Proportional Printing		
On	ESC Y	27 89
Off	ESC Z	27 90
Reset: Clear Print Buffer	CAN	24
Shift-In	SI	15
Shift-Out	SO	14
Software I-Prime	ESC } NUL	27 125 0
Subscript Printing On	ESC L	27 76
Subscript Printing Off	ESC M	27 77
Superscript Printing On	ESC J	27 74
Superscript Printing Off	ESC K	27 75

Okidata Command	ASCII	Decimal
Underline Printing On	ESC C	27 67
Underline Printing Off	ESC D	27 68
Uni-Directional Print On	ESC -	27 45
Uni-Directional Print Off	ESC =	27 61
Vertical Tab, Execute	VT	11

# Index

## Symbols

0 character (slashed, unslashed) 73, 80  
10 cpi (Front Panel Light) 18, 65  
12 cpi (Front Panel Light) 18, 65  
120 volt printer 99  
15 cpi (Front Panel Light) 18, 65  
17 cpi (Front Panel Light) 18, 65  
20 cpi (Front Panel Light) 18, 65  
230 or 240 volt printer 99  
300 cps (UTL) 95  
390 cps (HSD) 95  
435 cps (SSD) 95  
75 cps (NLQ) 95

## A

ABICOMP 73, 78  
Access  
    Controlling access to the printer 12  
Access Cover, Part Number 109

Accessories 107, 108  
    Part Numbers 108  
    Purchasing 107  
Acoustic Cover, Part Number 109  
Alarm  
    ALARM flashing 18, 32, 92  
    ALARM lit 18  
    ALARM lit, CPI 10 flashing 92  
    ALARM lit, CPI 15 flashing 93  
Alignment problems 12  
ASCII Test 35  
Auto Carriage return 78  
Auto CR+ 76  
Auto LF (Line Feed) 76, 78  
Auto Select 76

## B

Backward  
    Movement through Menu 10  
Bar Codes 96

Bi-Directional  
    Parallel Interface 77, 78  
Bi-directional  
    Communications 40  
    Printing 75, 79  
Block Graphics 73, 78  
Bottom Feed 97, 98, 99  
    Form Tear-Off 74  
    Line Spacing 74  
    Pull Tractor (Option) 108  
    Skip Over Perforation 74  
BRASC II 73, 78  
Brazil 104, 125  
British (Language) 73  
Buffer  
    Clearing 19, 79  
    Print 79  
    Receive Buffer Size 75, 80, 96

## C

- Cable
  - Length (Parallel) 40
  - Network Cable 39
  - Parallel 40
  - Shielded, Parallel 40
- Canada
  - Service 103, 105
  - Service Center (Oki Data) 104
- Canadian French 73, 78
- Carbon Forms 58
- Carbonless continuous forms 97, 98
- Cardstock 97, 98
  - Expanded printhead gap 59
- Centering 76, 78
  - Printhead Position 92
- Centronics parallel interface 96
- Character Pitch 79
  - Front Panel key 19
  - Indicator Lights 18
  - Key doesn't work 93
  - Selecting 65
- Character Set 73, 78
- Character Width 79
- Characters
  - Italics 80
  - Proportional Spacing 80
  - Special for languages 79
- Characters Per Second (CPS) 14
- Cleaning the printer 82
- Code 128 96
- Code 39 96
- Code DEL 76
- Code Page Character Set 78
- Codes, Printer Control 111
- Commands
  - Epson FX Commands 112, 113
  - IBM Proprinter III Commands 114
  - Microline Standard 116, 117
- Communication
  - with the network 77, 78
- Consumables
  - Part Numbers 108
  - Ribbon Cartridge 108
  - Ribbon Life 96
- Contact Information for Oki Data 2
- Contents list, unpacking the printer 24
- Continuous Feed
  - Carbonless Forms 97, 98
  - Changing to single-sheet feed 57
  - Extra-thick forms 58
  - Interleaf continuous forms 97, 98
  - Paper 94
  - Paper Park 19
  - Pins (graphic) 29
  - Rear Feed 16
  - Reference Mark 30
  - Single-part forms 29, 97, 98
- Control Codes 111
- Correspondence, Print Quality 63
- Costs, Cutting 9
- Courier (Font) 63, 96
- Covers, Part Numbers 109
- cpi 10 flashing, ALARM lit 92
- cpi 15 flashing, ALARM lit 93
- Cut Sheet Paper 97, 98
- Cutting Costs. *See* Money, Saving

## D

- Danish (Language) 73
- Data Word 78
  - 7 bit 76
  - 8 bit 76
- DC1 code 80
- DC3 code 80
- DEL Code 79
- Depth of printer 99
- Detergent, cleaning the housing 82
- Documentation 110
- Documents, Print Quality 63
- Draft
  - Draft Mode 73, 95
  - Print Quality 63
- Draft Mode
  - Saving money with 9
  - Saving time with 10
- Drivers
  - Diskette 68
  - Oki Data Web Site 68
  - Operating Systems 68
  - Requesting by mail 68
- Dutch (Language) 73

## E

- E-mail address for Oki Data 2
- EAN 13 96
- EAN 8 96
- Efficiency. *See* Time, Saving
- Electrical Requirements 99
- Emulation 66, 73
  - Changing 66
  - Choices 66, 95
  - Matching the printer driver 91
  - Mode 73, 78
- Envelopes 31
  - Continuous Feed 97, 98
  - Printhead Gap Setting 58
  - Single Feed 97, 98
- Environmental Requirements 99
- Epson
  - Emulation Mode, Epson FX 66, 73, 95
  - Epson FX Commands 112, 113
- Error Conditions
  - ALARM blinks 18
  - ALARM glows 18
- Ethernet 96
- Expanded Printhead Gap 59



## F

- Factory Defaults
  - Menu Mode 71
- FCC (Federal Communications Commission) 132
- FF/LOAD (Front Panel Key) 19
- First Aid Procedures 126
- Fonts
  - Embedded Printer Commands 91
  - Font Sample Test 19, 34
  - PRINT QUALITY key 19
  - Resident 96
  - Scalable 96
  - Size 65, 73, 96
  - Style 73
  - Wrong fonts print 67, 91
- Forms
  - Continuous
    - Carbonless 97, 98
    - Interleaf 97, 98
    - Single-part 97, 98
  - Multipart and Printhead Gap 58
  - Narrow width 92
  - Thick 59
  - Thickness ranges 14
  - Zero-Tear 14

- Forms Tear-Off 79
  - Automatic 52
  - Bottom Feed 74
  - Changing 51
  - Forms Tear-Off OFF
    - TEAR key 55
    - Top of Form 46
  - Forms Tear-Off ON
    - TEAR key 55
    - Top of Form 44
  - Manual 54
  - Rear Feed 74
  - Saving money with 9
  - Status (ON or OFF) 43
  - TEAR key 19, 53
  - Top of Form 43
  - Wait Time 80
- French (Language) 73
- French Canadian (Language) 73
- Front Panel
  - Keys 12, 19, 76
    - Alternate Functions 19
    - Won't work 12, 76, 79
  - Lights 18
  - Menu Mode 69

## G

- German (Language) 73
- Gothic (Font) 96
  - HSD Print Quality 63
  - Near Letter Quality 63
  - SSD Print Quality 63
  - Utility Print Quality 63
- Graphics 78
  - 7 bit 75
  - 8 bit 75
  - Printing 79
    - Bi-directional 75
    - Uneven print registration 50, 51, 52
    - Uni-directional 75
  - Resolution 96
- GROUP, Menu Mode 69

## H

- Height
  - Double height printing 80
  - of Printer 99
- Help. *See* Service and Support
- High Speed Draft (HSD)
  - Front Panel Light 18
  - Mode 14, 95, 96
  - Print Quality 63
- HSD. *See* High Speed Draft
- Humidity
  - Operating 99
  - Storage 99

## I

- I-Prime 77, 79, 90
- IBM
  - IBM 437 78
  - IBM 850 78
  - IBM 860 78
  - IBM 863 78
  - IBM 865 78
  - IBM Emulation 66
  - IBM PPR 73
  - IBM Proprinter III 95
  - IBM Proprinter III Commands 114
  - IBM Set I 78
  - IBM Set II 78
- IC. *See* Industry Canada
- IEEE-284 96
- Impact Dot Matrix 95
- Industry Canada 133
- Initialization string 90
- Initialize the printer 64
- Installation
  - Customization 22
  - Local printer 36
  - Network 39
  - Network Printer 38
  - Printer Software 36, 37

- Interface 96
  - Ethernet 96
  - Parallel 12, 40
    - Doesn't work 94
- Interleaf Continuous Forms 97, 98
- Interleaved 2 of 5 96
- Internet 13
  - Oki Data Web Site
    - 2, 102, 104, 106, 123, 124, 125
    - Saving time with 10
- Invalid (I-Prime command) 79
- ISO 8859-15 73, 78
- Italian (Language) 73
- Italic 73, 80
- Item, Menu Mode 69
  - Explanations of Items 78, 79, 80
  - Settings 69

## J

- Japanese (Language) 73

## K

- Keys, Front Panel 19

## L

Labels 97, 98  
    Paper Park 56  
    Printhead Gap Setting 58  
Language 73, 79  
Latin America  
    Customer Support 123  
    Language 73  
    Locating a service center 104, 125  
    Service 106  
    Warranty 120  
Length, Page  
    Bottom Feed 74  
    Control, Top Feed 75  
    Rear Feed 74  
    Top Feed 75  
Letterhead 31  
LF (Line Feed) Front Panel key 19  
Lights, Front Panel 18  
Limited Operation 12, 79, 93  
Line Graphics 73, 78  
Line Spacing 79  
    Bottom Feed 74  
    Rear Feed 74  
    Top Feed 75

Local printer installation 36  
Lock Lever (graphic) 29

## M

Mailing address for Oki Data 2  
Maintenance  
    Cleaning the printer housing 82  
    Replacing the ribbon cartridge 81  
Margin, Bottom 75, 78  
Material Safety Data Sheet (MSDS)  
    126  
Mean Time Between Failures (MTBF)  
    14, 96  
Mean Time to Repair (MTTR) 96  
Memory, Receive Buffer size  
    75, 80, 96  
Memos 31  
MENU light 69  
Menu Mode 69  
    Changing Settings 72  
    Entering 70  
    Exiting 70  
    Explanations of Menu Items  
        78, 79, 80

Front Panel keys 69  
Group 69  
Item 69  
Losing setting changes 72  
MENU light 69  
Moving through 10, 70  
Printing the Menu Settings 71  
Reset to factory defaults 71  
Saving time 10  
SEL and SHIFT keys 19  
SEL on power up 19  
Set (Item Setting) 69  
    Settings Table 73, 74, 75, 76, 77  
Mexico 104, 125  
Microline Commands 116, 117  
Microline Emulation 66, 73, 95  
Microline Reference Manual 111  
ML. *See* Microline  
Money, Saving 9  
Moving through the menu 10  
MSDS. *See* Material Safety Data Sheet  
Multilingual 73, 78  
Multilingual 858 73, 78  
my.okidata.com 41, 102, 124

## N

- Near Letter Quality (NLQ) 63, 95, 96
  - Front Panel Light 18
- Network
  - Card and parallel port 12, 94
  - Communication 77, 78
  - Installation 39
  - Printer Installation 38
  - Specifications 95
- NLQ. *See* Near Letter Quality
- Norwegian 78
  - Code Page 73
  - Language 73

## O

- Off-line, SEL key 19
- Oki Data
  - Contact Information
    - e-mail 2
    - Latin America 104
    - mailing address 2
    - telephone 103, 104, 107, 122
  - Service Centers 104, 125
  - Web Site 2, 123, 125
- On-line, SEL key 19
- Operating Systems 68
- Operator Panel Function 93
- Options 107
  - Descriptions 108
  - Part Numbers 108
  - Purchasing 107
- Out of Paper
  - ALARM glows, no other lights 18

## P

- Packing for Shipment 25
- Page Length 79
  - Bottom Feed 74
  - Rear Feed 74
  - Top Feed 75
- Page Width 79
  - Bottom Feed 74
  - Rear Feed 74
- Setting in the Printer Menu 75, 79
- Top Feed 75

- Paper
  - 1" (25 mm) remains 79
  - Continuous Feed
    - Alignment 30
    - Rear Feed 29
  - Feeding 14
  - Loading 29
  - Paper Out Override 75, 79
  - Roll Paper 108
  - Single Sheet 29, 31
  - Specifications 97, 98
  - Static 94
  - Thickness 99
  - Types, and Printhead Gap 58
  - Weight 97, 98
  - Widths 97, 98
    - Setting in the Printer Menu 75, 79
- Paper Feed
  - Continuous to single-sheet feed 57
  - FF/LOAD key 19
  - LF key 19
  - PARK key 19
  - QUIET key 19
  - Roll Paper Stand (Option) 108
  - Single-sheet to continuous-feed 57
  - Switching feed paths 57
  - TEAR key 19
- Paper Jams 93
  - ALARM glows, 15 cpi blinks 18
  - Continuous feed 94
  - Rear Feed 83
  - Rear Feed, repetitive 85
  - Single Sheet 87
- Paper Lever 92
  - ALARM glows, 10 cpi blinks 18
  - REAR feed position (graphic) 29
- Paper Out 93
- Paper Park 56
  - Labels 56
  - Saving time with 10
- Paper Path, Switching 57
- Paper Separator 94
- Parallel Interface 12, 40, 77
  - Bi-Directional 77, 78
  - Doesn't work 94
  - I-PRIME Signal 90
- Parallel Port. *See* Parallel Interface
- PARK Front Panel Key 19, 31
- Parts, Replacement 107
  - Part Numbers 108
  - Purchasing 107
- Perforation, Skip over 74, 80
- Pin 14 78
- Pitch, Character 73, 79
- Platen Knob
  - Operation Tip 12
  - Part Number 109
- Port
  - Logical Port 36
  - Parallel 36, 40
- Portugal 73, 78
- Postnet 96

## Power

- Connecting the printer to 28
- Front Panel Light lit 18
- Grounded Outlets 20, 130
- Nothing happens when printer is turned on 91
- Power Rating 20, 130
- Print DEL code 76
- PRINT, Menu Mode 69
- Print Method 95
- Print Mode 73, 79
- Print Quality
  - ASCII Test 35
  - CHARACTER PITCH key 19
  - Font Sample Test 34
  - Front Panel key 19
    - doesn't work 93
  - Highest (NLQ) 63
  - Indicator Lights 18
  - Low (HSD) 63
  - Lowest (SSD) 63
  - Medium (UTL) 63
  - Near Letter Quality 95
  - PRINT QUALITY key 19

## Print Speed 14

- Proportional Spacing 80
- Selecting 63, 79
- Software commands 63
- Print Registration 75, 79
  - Forms Tear-Off 50, 51, 52
  - Shift left 75
  - Shift right 75
- Print Size 95
  - Smallest 65
  - Standard 65
- Print Speed 14, 95
  - High (HSD) 63
  - Highest (SSD) 63
  - Medium (UTIL) 63
  - Selecting 79
  - Slowest (NLQ) 63
- Print Start Position
  - Reset to factory default position 49
  - Temporary adjustment 48
  - Top of Form 42, 48, 49
- Print Suppress 76, 80

## Printer

- Dimensions 99
- Humidity Specifications 99
- Initialization 64
- Model Number 107
- Parameters 10
- Parts and Accessories 107, 108
- Printer vs. software settings 90
- Reset 19, 64
- Serial Number 15
- Size 99
- Temperature Specifications 99
- Weight 99
- Printer Control Codes 111
- Printer Drivers
  - matching the emulation 91
  - Obtaining 68
  - Operating systems 68
  - Selecting 67
- Printer Parameters 69

- Printhead 95
  - Centering position 78, 92
  - Heat 130
  - Life 96
  - New printhead 92
  - Part Number 109
- Printhead Gap 14
  - Adjusting 58
  - Definition 58
  - Expanded 59
  - Extra-thick continuous forms 58
  - Settings, and Media types 58
- Printing
  - Double width and height 80
  - Embedded Commands 91
  - Italics 80
  - Parallel port doesn't work 94
  - Problems
    - Files don't print correctly 90
    - Incorrect fonts print 67, 91
    - Printer doesn't print 91
    - Smeared print 92
    - Strange characters print 67

- Strange symbols print 91
- Streaked printing 92
- Stopping 75, 80, 96
- Product
  - Registering your printer 41
- Productivity. *See* Money, Saving; Time, Saving
- Proof of Purchase 105
- PROP
  - characters per inch (dpi) 65
  - Front Panel Light 18
- Proportional Spacing 65, 73, 80
- Proprinter III Commands 114
- Publisher (Language Set) 73
- Pull Tractor 14, 58, 99, 108
- Pull-Up Roller Assembly 109
- Push Tractor 14, 58, 99, 108

## Q

### QUIET

- Front Panel Key 19
- Front Panel Light 18

## R

- Radio Interference Statement 132, 133
- Rear Feed 97, 98, 99
  - Continuous Forms 16, 29
  - Form Tear-Off 74
  - Jams, Repetitive 85
  - Line Spacing 74
  - Paper Jam 83
  - Skip Over Perforation 74
- Receive Buffer size 75, 80, 96
- Registration, Print 75, 79
- Registration, Product (Warranty) 41
- Regulatory Information
  - Canada 133
  - Europe 134
  - United States 132
- Reliability 14, 96
- Replacement Parts 107, 108
  - Part Numbers 109
- Reset 76
  - Reset Code 90
  - Reset Inhibit 80, 90
  - the printer 64, 93
- Resolution (Graphics) 96
- Reverse, Moving through the Menu 10

Ribbon Cartridge 108  
  Installing 26  
  Life 96  
  New Ribbon Cartridge 92  
  Replacing 26, 81  
Ribbon Shield 26, 92  
Roll Paper Stand 108  
Rolling ASCII Test 19

## S

Safety, General Information 130  
Saving Money. *See* Money, Saving  
Saving Time. *See* Time, Saving  
Security  
  Controlling access to the printer 12  
SEL  
  Front Panel Key 19  
  Front Panel Light  
    Flashes 18  
    Lit 18  
    Not Lit 18, 91  
Self Tests 33

Serial Number 15  
Service and Support 100  
  ALARM flashing 92  
  Authorized Service Centers  
    104, 121, 123, 125  
  Documentation 101  
  General Information 100  
  Internet Support 13, 102  
  Locating a service center 106, 125  
    Canada 121  
    Latin America 106  
    United States 103, 105, 121  
  Machine Reliability 96  
  Mean Time Between Failures  
    (MTBF) 14, 96  
  Mean Time To Repair (MTTR) 96  
  Oki Data Service Centers 104, 125  
  Purchase Location 101  
  Registering your product 41  
  Telephone Support 103  
  Warranty 118, 120  
Set, Menu Mode 69

SHIFT Front Panel Key 19  
Shipping  
  Restraints 25  
  Saving the packing materials 25  
SI 76, 80  
Single Sheet  
  Change from continuous forms 57  
  Change to continuous forms 57  
  Jams 87  
  Loading 31  
  Top Feed 17, 29  
Size  
  Print Size, Double width and height  
    80  
  Printer Dimensions 99  
Skip Over Perforation 74



## T

### Software

- Embedded commands 91
  - Installation 36, 37
  - Matching drivers to emulations 91
  - Scalable Fonts 96
  - Software vs. printer settings 90
- ### Solvents, cleaning 82
- ### Spanish (Language) 73
- ### Specifications 95
- Network 95
- ### Spreadsheets, Character Pitch 65
- ### SSD. *See* Super Speed Draft
- ### Standard Character Set 73, 78
- ### Static charges and paper 94
- ### Stationery 31
- ### Super Speed Draft (SSD)
- 14, 63, 64, 78
  - Front Panel Light 95, 96
- ### Support. *See* Service and Support
- ### Swedish (Language) 73
- ### Symbol Sets 73, 79

### Take-up Knob (Ribbon Cartridge) 26

### TEAR

- Front Panel key 19, 55
  - Forms Tear-Off 53
  - Forms Tear-Off OFF 55
  - Forms Tear-Off ON 55
- ### TEAR feature 50
- does not work
  - 50, 51, 52, 54, 55

### Telephone

- Oki Data Support 103, 104, 107
- Latin America 104

### Temperature Specifications 99

### Tests

- ASCII Test 35
- Font Sample Test 34

### Thickness, Paper 99

### Time Out 76, 80

### Time, Saving 10

### Top Feed 97, 98

- Bottom Margin 75
- Line Spacing 75
- Pull Tractor 108
- Single Sheet 17, 29

### Top of Form 78

- Decreasing the space 45, 47
- Forms Tear-Off 43
- Forms Tear-Off OFF 46
- Forms Tear-Off ON 44
- Increasing the space 45, 47
- Operation Tip 11
- Paper Shield 11, 42
- Reset to factory default 49
- Printer OFF 49
- Printer ON 49
- Setting 42
- Standard Setting
- 31, 32, 42, 48, 49
- Temporary adjustment 48

### Tractor Covers 29

### Transparencies 97, 98

## Troubleshooting

- Aborting print jobs 75, 80, 96
- ALARM flashing 18, 92
- ALARM lit 18
- ALARM lit, 10 cpi flashing 18, 92
- ALARM lit, 15 cpi flashing 18, 93
- ALARM lit, no other lights 18
- Alignment problems 12
- Can't load paper 93
- Character Pitch Indicator Lights 18
- Data loss 78, 79, 80
- Embedded Printer Commands 91
- Emulation 91
- Extra paper movement 50, 51, 52
- Files don't print correctly 90
- Front Panel Keys 19
- Front Panel keys won't work 12, 76, 93
- Front Panel Lights 18
- General Information 88
- Internet Support 88
- List of Problems 89
- Locating a service center 106
- Menu Setting changes are lost 72

- Narrow forms 92
- New ribbon 92
- Oki Data Suport (Telephone) 103
- Oki Data Suport (Web Site) 124
- Oki Data Support (Telephone) 103, 104, 107
  - Latin America 104
- Oki Data Support (Web Site) 102, 104, 106, 124
- Paper jams, continuous feed 94
- Paper Out 93
- Parallel port doesn't work 12, 94
- Perforation skip over 80
- POWER lit 18
- PRINT QUALITY and CHARACTER PITCH keys don't work 12, 79, 93
- Print Quality Indicator Lights 18
- Print Registration 75
- Printer doesn't print 91
- Printer Drivers, current version 68
- Printhead Damage 78, 79

- Printhead moves too much 92
- QUIET lit 18
- SEL
  - flashing 18
  - lit 18
  - not Lit 18
- Self Tests 33
- Smearred printing 92
- Software settings vs. printer settings 63, 80
- SSD won't work 78
- Static charges 94
- Strange characters print 67
- Streaked printing 92
- Turn on the printer, nothing happens 91
- Uneven print registration in graphics 50, 51, 52
- Weather conditions 94
- Wrong fonts print 67, 91
- Wrong printer driver 67

## U

- Uni-directional printing, graphics 75
- United States
  - Customer Support 122
  - Locating a service center 125
  - Service 103, 105, 121
  - Service Center (Oki Data) 104, 125
  - Warranty 118
- Unpacking your printer
  - List of contents 24
- UPC A 96
- UPC E 96
- USA 73, 78
- UTIL (Front Panel Light) 18, 95, 96
- Utility. *See also* UTL
  - Utility Mode Print Quality 63
  - Utility Mode Print Speed 14
- UTL 63

## V

- Volume
  - High-volume print quality 63

## W

- Wait Time 75, 80
- Warranty
  - Latin America 120
  - Proof of Purchase 105
  - Registering your printer 41
    - Methods 41
  - United States and Canada 118
- Web Site, Oki Data 2
- Weight
  - Paper 97, 98
  - Printer 99

## Width

- Character 79
- Double width printing 80
- Page (Bottom Feed) 74
- Page (Rear Feed) 74
- Page (Top Feed) 75
- Paper 97, 98
  - Setting in the Printer Menu 75, 79
- Printer 99
- [www.okidata.com](http://www.okidata.com)
  - 102, 104, 106, 123, 124, 125

## Y

- Y2K 131
- Year 2000 131

## Z

- Zero character (slashed, unslashed)
  - 73, 80